

Certificat

Renforts acier pour produits de la baie

Baies, portes, vérandas et accessoires

Le CSTB atteste que les produits mentionnés dans ce certificat sont conformes aux caractéristiques décrites dans le référentiel de certification QB « Renforts acier pour produits de la baie » (QB44) en vigueur après évaluation selon les modalités de contrôle définies dans ce référentiel.

En vertu de la présente décision, le CSTB accorde à :

la société **LAMSO**
19 rue des Frères Lumière
FR-33327 EYSINES

usine : **LAMSO**
19 rue des Frères Lumière
FR-33327 EYSINES

le droit d'usage de la marque QB « Renforts acier pour produits de la baie » pour les produits objets de cette décision, pour toute sa durée de validité et dans les conditions prévues par les exigences générales de la marque QB et le référentiel mentionné ci-dessus.



02

Décision d'extension n° 1042-02 du 17 avril 2024

Cette décision se substitue à la décision d'extension n° 1041-02 du 29 février 2024

Le certificat en vigueur peut être consulté sur le site internet <https://evaluation.cstb.fr> pour en vérifier sa validité.

CARACTÉRISTIQUES CERTIFIÉES

> Caractéristiques dimensionnelles (géométrie du renfort et épaisseur)

> Classe de protection anti-corrosion : PZ275

Ce certificat comporte 23 pages.

Correspondant :

Direction Baies et Vitrages
QB44@cstb.fr
+33(0)1 64 68 84 45

Par déléation
du Président



Florian RASSE

Certificate

Steel reinforcements for window products

Windows, doors, verandas and accessories

CSTB hereby certifies that the above-mentioned product complies with the characteristics described in the certification reference system QB "Steel reinforcements for window products" (QB44) in force, following an assessment performed according to the inspection procedures set out in this reference system.

By virtue of the present decision, CSTB grants:

the company **LAMSO**
19 rue des Frères Lumière
FR-33327 EYSINES

plant : **LAMSO**
19 rue des Frères Lumière
FR-33327 EYSINES

the right to use the QB mark "Steel reinforcements for window products" for the product covered under this decision, throughout its period of validity and under the conditions stipulated under the general requirements of the QB mark and the above-mentioned reference system.



02

Decision of extension no. 1042-02 dated 17th April 2024

This decision takes the place of the decision of extension no. 1041-02 dated 29th February 2024

This valid certificate may be watched on the following web site <https://evaluation.cstb.fr> to check its validity.

CERTIFIED CHARACTERISTICS

> Dimensional characteristics (reinforcement geometry and thickness)

> Anti-corrosion protection class : PZ275

This certificate includes 23 pages.

Contact :

Windows and Glazing Department
QB44@cstb.fr
+33(0)1 64 68 84 45

For CSTB
On behalf of the President



Florian RASSE

Décision d'extension n° 1042-02 du 17 avril 2024
Decision of extension no. 1042-02 dated 17th April 2024

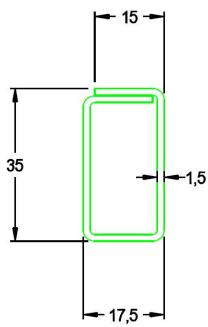
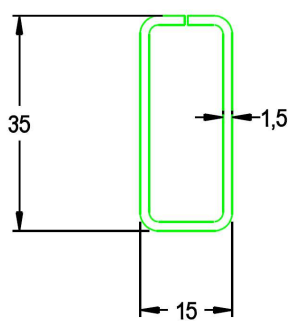
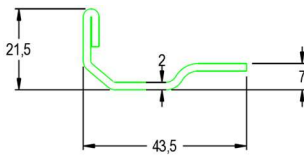
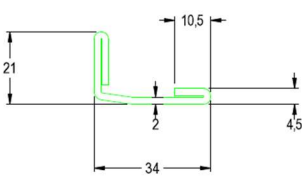
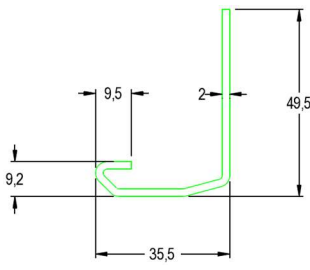
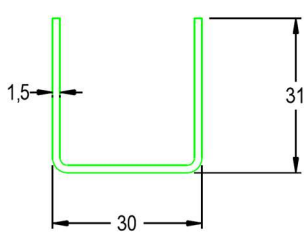
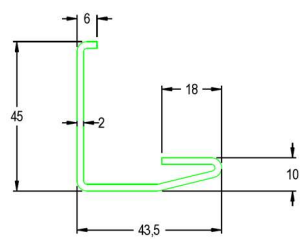
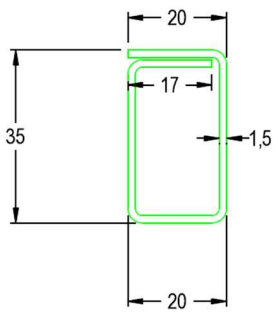
ALUPLAST Idéal 2000 (6/16-2301)			
<p>2290376000012</p> 	<p>229110</p> 	<p>2290076000012</p> 	<p>2290556000012</p> 
<p>2290566000012</p> 	<p>2290016000012</p> 	<p>2290736000012</p> 	<p>229101</p> 

Décision d'extension n° 1042-02 du 17 avril 2024
Decision of extension no. 1042-02 dated 17th April 2024

ARBAN GROSFILLEX GX75 (6/15-2239)

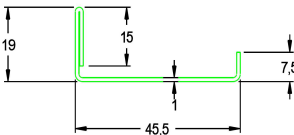
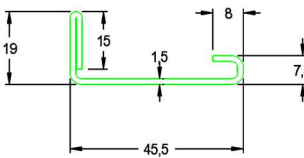
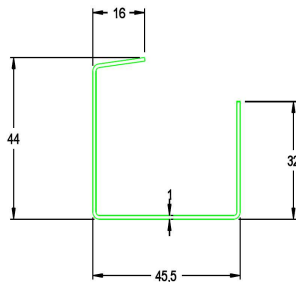
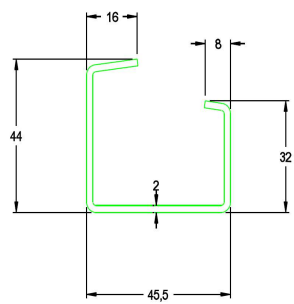
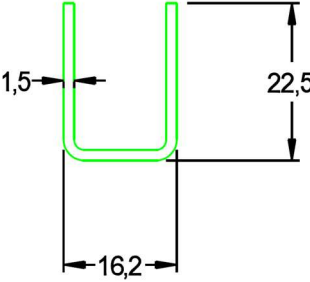
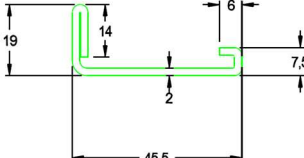
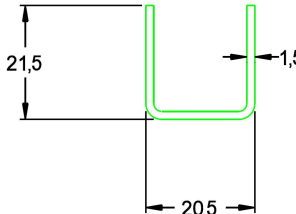
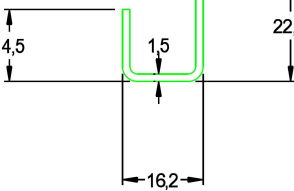
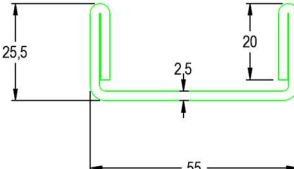
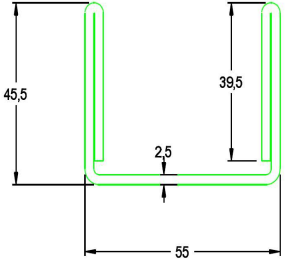
<p>RA701.1</p> 	<p>RA701.2</p> 	<p>RA710.1</p> 	<p>RA710.2</p> 
<p>RA727</p> 	<p>RA701.3</p> 	<p>RA722</p> 	<p>RA725</p> 
<p>RA720.1</p> 	<p>RA731.2</p> 	<p>-</p>	<p>-</p>

Décision d'extension n° 1042-02 du 17 avril 2024
Decision of extension no. 1042-02 dated 17th April 2024

ANDRE BOUVET Bouvet Odace (6/16-2344)

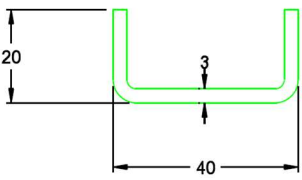
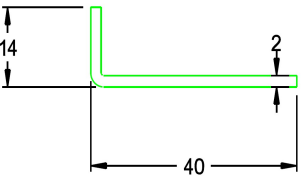
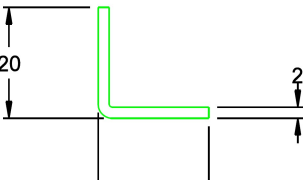
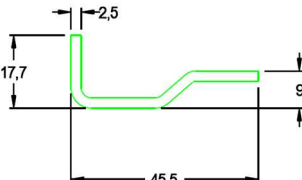
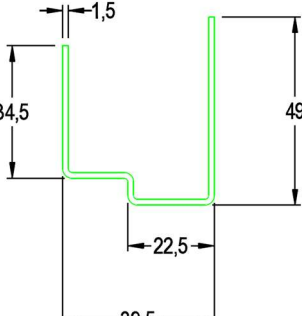
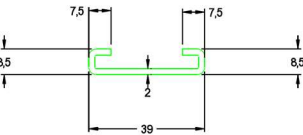
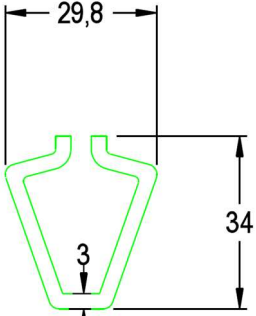
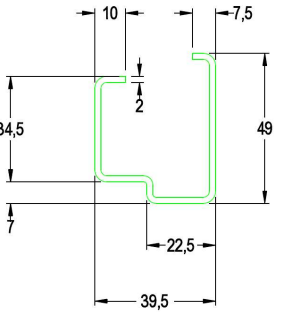
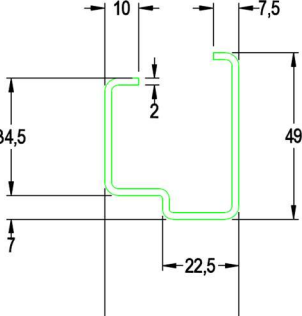
<p>REN 006</p> 	<p>REN 048GALV</p> 	<p>REN 049GALV</p> 	<p>REN017</p> 
<p>REN054GALV IndiceB</p> 	<p>RENO 028 Indice B</p> 	<p>REN 020</p> 	<p>REN056GALV</p> 
<p>REN060GALV</p> 	<p>-</p>	<p>-</p>	<p>-</p>

Décision d'extension n° 1042-02 du 17 avril 2024
Decision of extension no. 1042-02 dated 17th April 2024

ANDRE BOUVET Coloriance (6/12-2018)

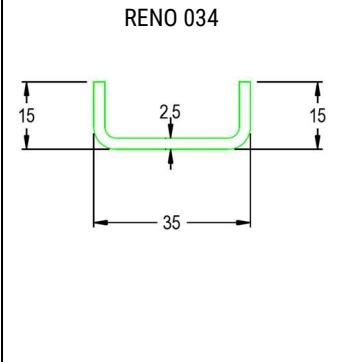
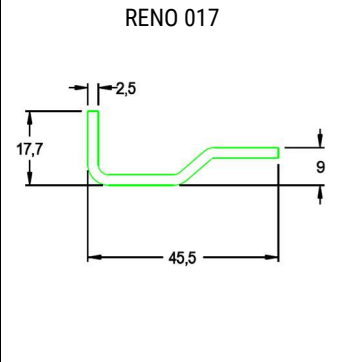
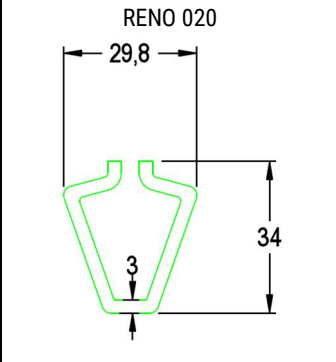
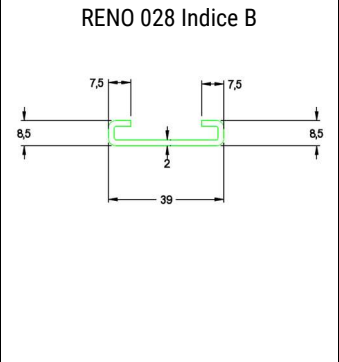
RENO 034	RENO 017	RENO 020	RENO 028 Indice B
			

Décision d'extension n° 1042-02 du 17 avril 2024
Decision of extension no. 1042-02 dated 17th April 2024

ANDRE BOUVET Frappe COLORIANCE+ (6/19-2392)

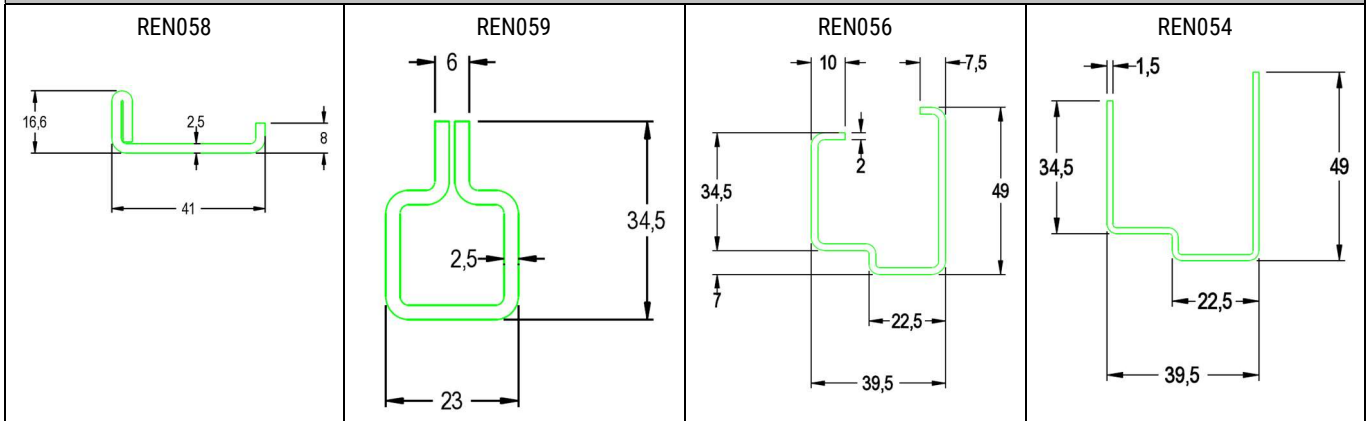

Décision d'extension n° 1042-02 du 17 avril 2024
Decision of extension no. 1042-02 dated 17th April 2024

ANDRE BOUVET Thermience (6/14-2215)

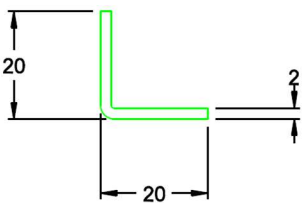
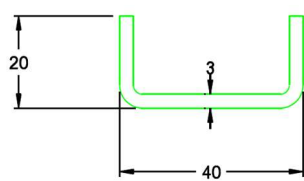
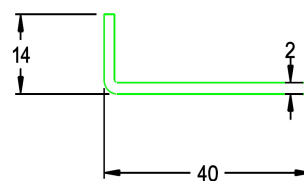
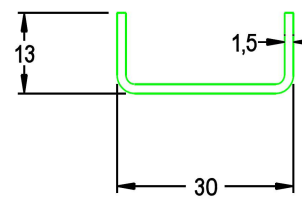
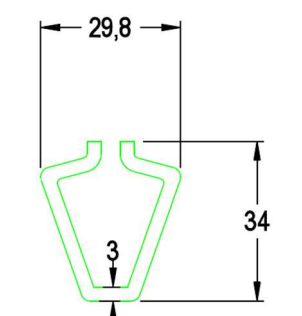
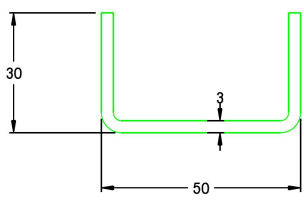
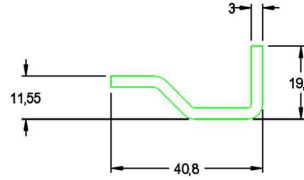
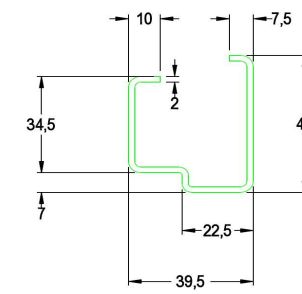
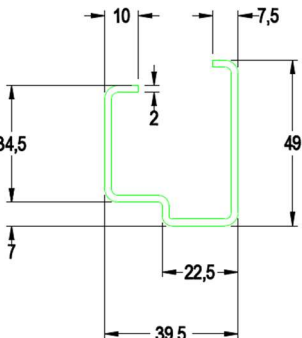
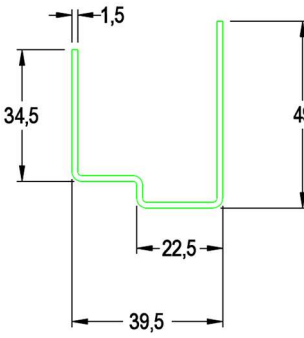
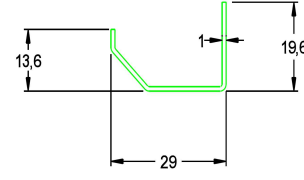
<p>REN049GALV</p> 	<p>REN006GALV</p> 	<p>REN048GALV</p> 	<p>REN068GALV</p> 
<p>REN020GALV</p> 	<p>REN007GALV</p> 	<p>REN021GALV</p> 	<p>REN056GALV</p> 
<p>REN060GALV</p> 	<p>REN054GALV Indice B</p> 	<p>REN061GALV</p> 	-

Décision d'extension n° 1042-02 du 17 avril 2024
Decision of extension no. 1042-02 dated 17th April 2024

ANDRE BOUVET Thermience (6/14-2215) – les références de renforts ci-dessous ne sont pas décrites dans le DTA / The following reinforcement references are not described in the DTA

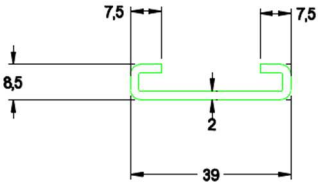
<p>REN028GALV Indice B</p> 	-	-	-
--	---	---	---

Décision d'extension n° 1042-02 du 17 avril 2024
Decision of extension no. 1042-02 dated 17th April 2024

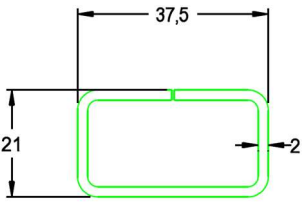
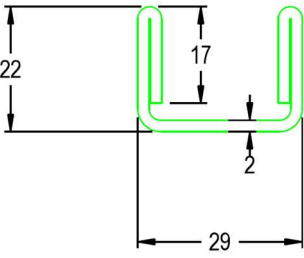
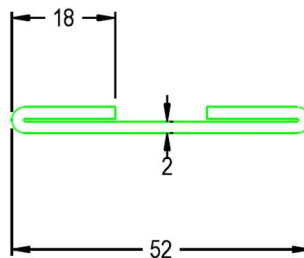
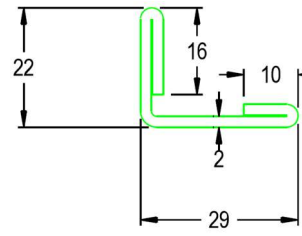
COUGNAUD Equinoxe (6/16-2333)			
R7111	R7096	R7159	R7094
			

Décision d'extension n° 1042-02 du 17 avril 2024
Decision of extension no. 1042-02 dated 17th April 2024

COUGNAUD Évolution (6/16-2328)			
<p>R7123</p>	<p>R7127</p>	<p>R7122</p>	<p>R7134</p>
<p>R7178</p>	<p>R7129</p>	<p>R7121</p>	<p>R7118_2mm</p>
<p>R7125</p>	<p>R7169</p>	<p>R7152</p>	<p>R7153</p>
<p>R7195</p>	<p>R7135</p>	<p>R7287</p>	<p>R7173-2</p>

Décision d'extension n° 1042-02 du 17 avril 2024
Decision of extension no. 1042-02 dated 17th April 2024

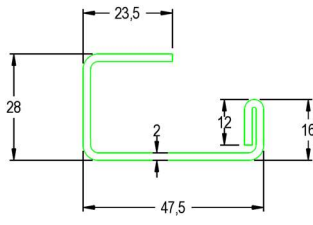
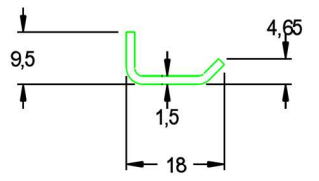
COUGNAUD Évolution (6/16-2328)			
R7174	R7126	-	-
			

COUGNAUD Évolution (6/16-2328) – les références de renforts ci-dessous ne sont pas décrites dans le DTA / The following reinforcement references are not described in the DTA

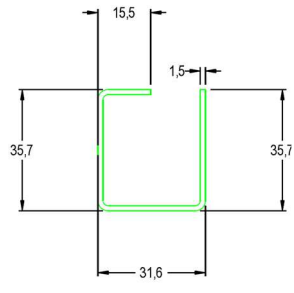
R7198	-	-	-
			

Décision d'extension n° 1042-02 du 17 avril 2024
Decision of extension no. 1042-02 dated 17th April 2024

DECEUNINCK Plateforme ZENDOW (6/16-2298)

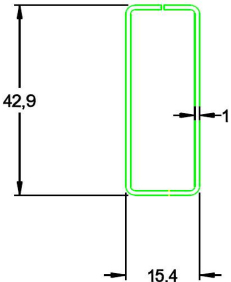
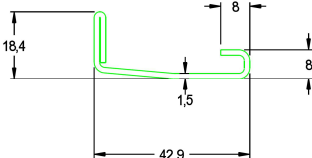
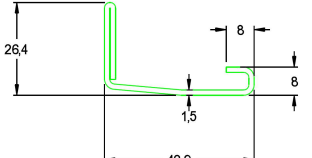
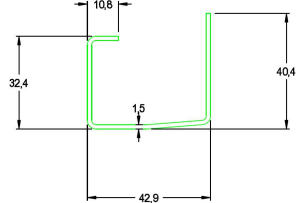
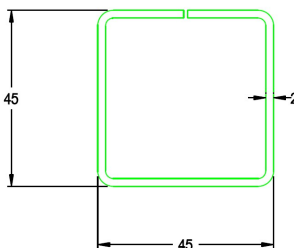
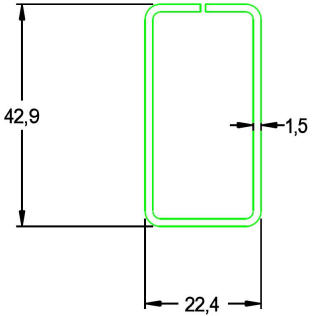
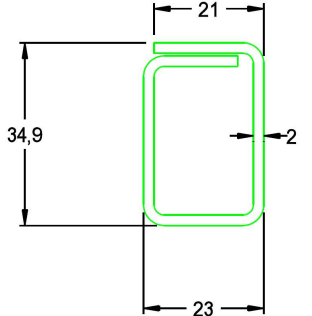
<p>3200</p> 	<p>3212</p> 	<p>3214</p> 	<p>3216</p> 
<p>3223</p> 	<p>3232</p> 	<p>3241</p> 	<p>-</p>

Décision d'extension n° 1042-02 du 17 avril 2024
Decision of extension no. 1042-02 dated 17th April 2024

LES ZELLES LZ (6/13-2138)

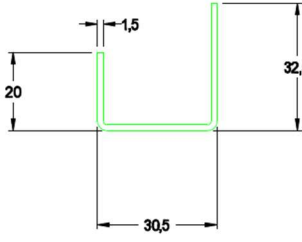
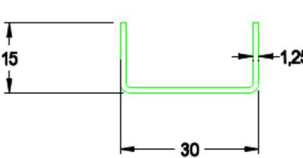
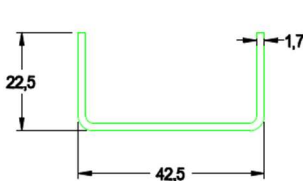
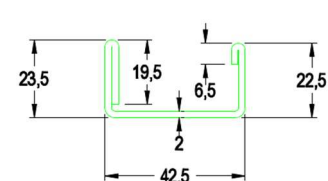
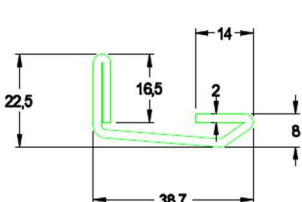
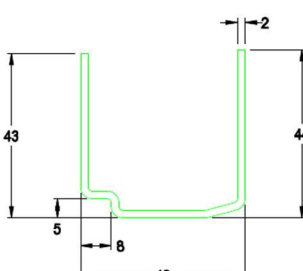
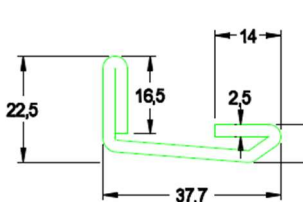
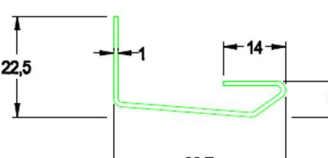
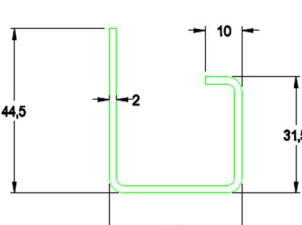
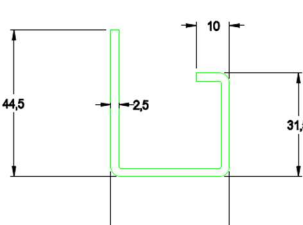
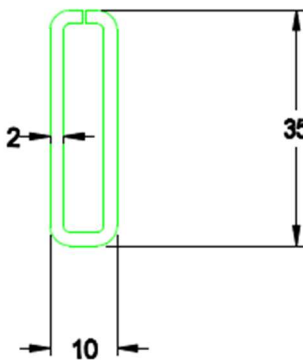
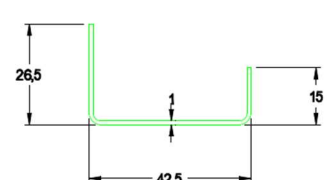
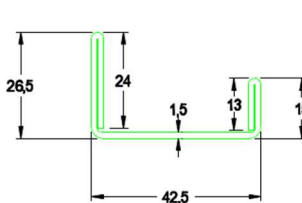
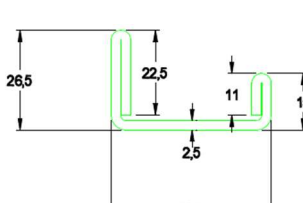
<p>R7179</p> 	<p>R7181</p> 	<p>R7185</p> 	<p>R7186</p> 
<p>R7214</p> 	<p>R7205</p> 	<p>R7215</p> 	<p>R7230</p> 
<p>R7216</p> 	<p>R7217</p> 	<p>R7218</p> 	<p>R7202</p> 
<p>R7203</p> 	<p>R7204</p> 	<p>-</p>	<p>-</p>

Décision d'extension n° 1042-02 du 17 avril 2024
Decision of extension no. 1042-02 dated 17th April 2024

PROFINE TROCAL e.XCLUSIVE, KBE e.MOTION, KÖMMERLING e.VOLUTION (6/16-2335)

<p>V600</p>	<p>V601</p>	<p>V030</p>	<p>9132</p>
<p>V081</p>	<p>9111</p>	<p>V603</p>	<p>V057.2</p>
<p>V258</p>	<p>V158</p>	<p>V059.2</p>	<p>V543-1</p>
<p>V544</p>	<p>V618</p>	<p>-</p>	<p>-</p>

Décision d'extension n° 1042-02 du 17 avril 2024
Decision of extension no. 1042-02 dated 17th April 2024

PROFINE TROCAL 76 ADVANCED, KBE 76 ADVANCED, KÖMMERLING 76 ADVANCED (6/16-2334)

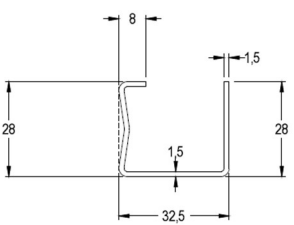
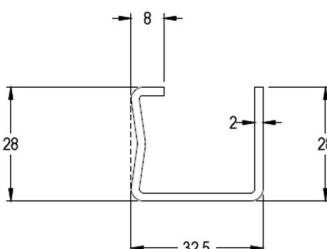
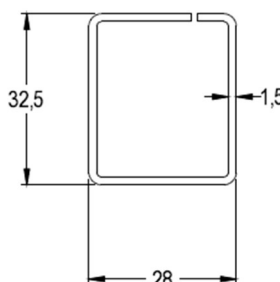
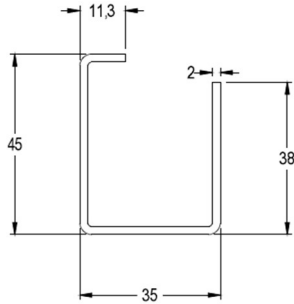
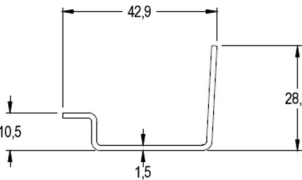
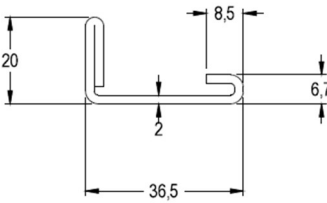
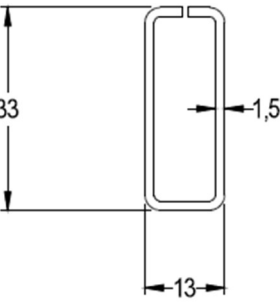
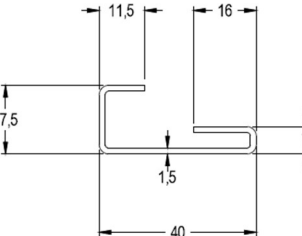
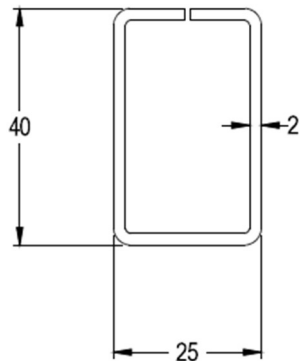
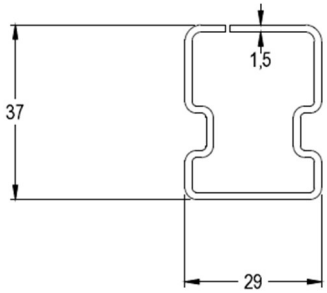
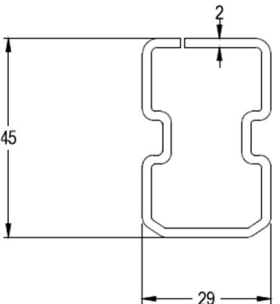
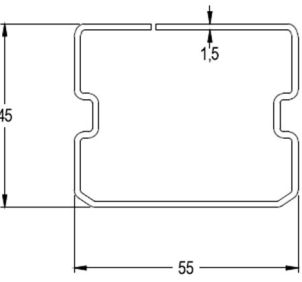
<p>V306</p> 	<p>V307</p> 	<p>V309</p> 	<p>V326</p> 
<p>V291</p> 	<p>V266</p> 	<p>V312</p> 	<p>V316</p> 
<p>V317</p> 	<p>V320</p> 	<p>V318</p> 	<p>V323</p> 

Décision d'extension n° 1042-02 du 17 avril 2024
Decision of extension no. 1042-02 dated 17th April 2024

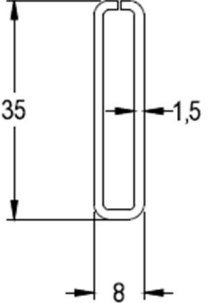
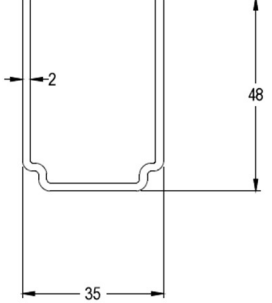
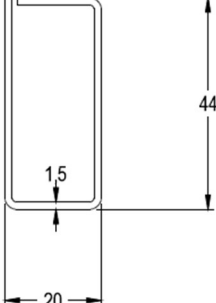
PROFINE PREMILINE (6/12-2045)			
<p>V081</p> 	<p>V106</p> 	<p>V107</p> 	-

Décision d'extension n° 1042-02 du 17 avril 2024
Decision of extension no. 1042-02 dated 17th April 2024

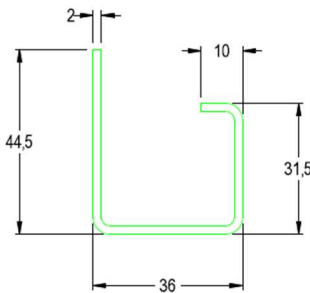
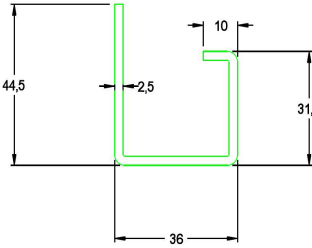
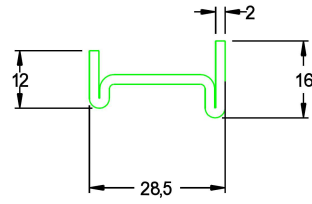
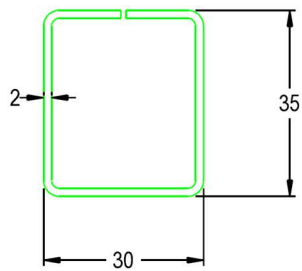
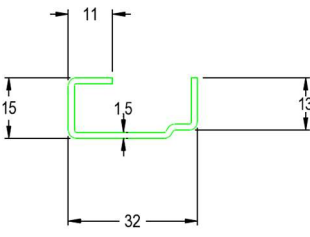
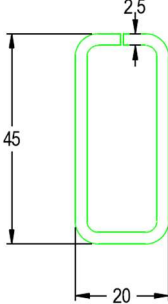
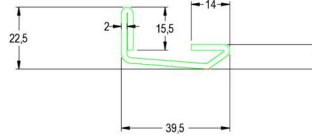
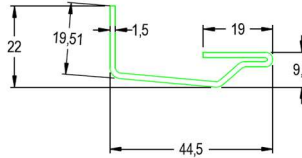
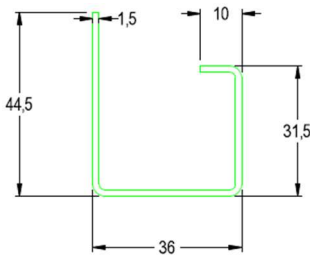
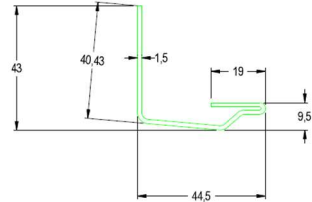
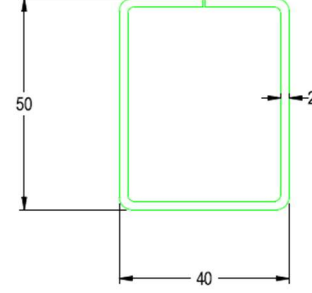
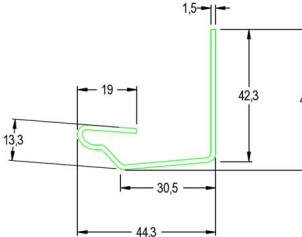
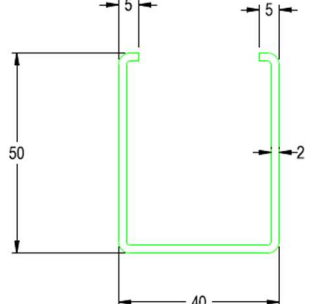
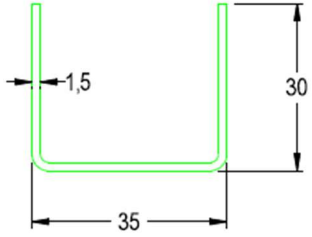
REHAU S729 (6/11-2003)			
<p>351109</p> 	<p>351868</p> 	<p>354202</p> 	<p>283089</p> 
<p>382812</p> 	<p>239353</p> 	<p>351696</p> 	<p>351045</p> 
<p>349109</p> 	<p>351047</p> 	<p>250475</p> 	<p>351046</p> 
<p>268742</p> 	<p>283369 - R3</p> 	-	-

Décision d'extension n° 1042-02 du 17 avril 2024
Decision of extension no. 1042-02 dated 17th April 2024

SOCREDIS LUXline (6/16-2342)

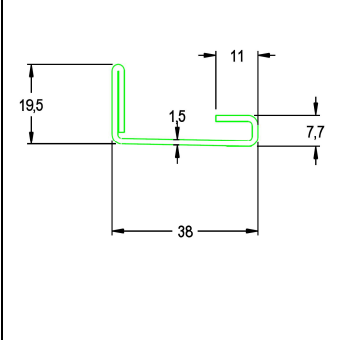
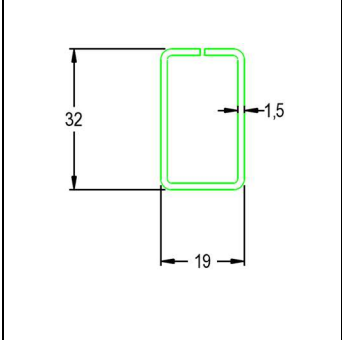
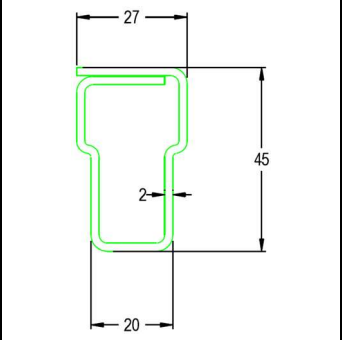
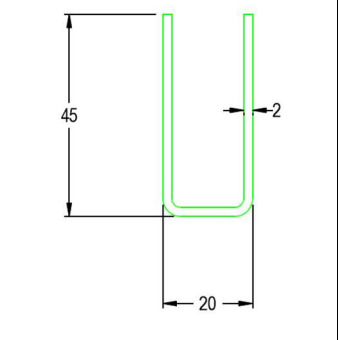
RF601	RF603	RF504	RF505
			

Décision d'extension n° 1042-02 du 17 avril 2024
Decision of extension no. 1042-02 dated 17th April 2024

SOCREDIS WISIO Frappe (6/14-2194)

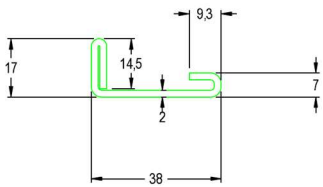
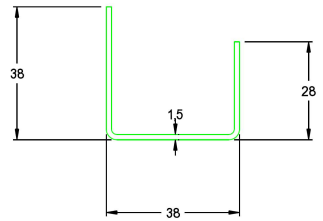
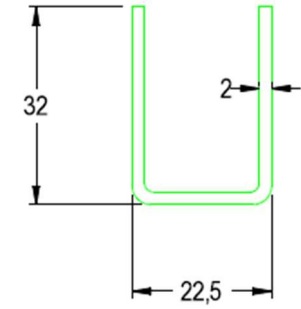
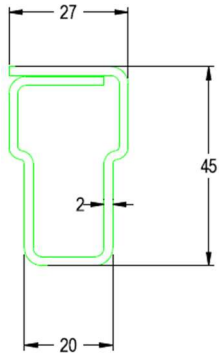
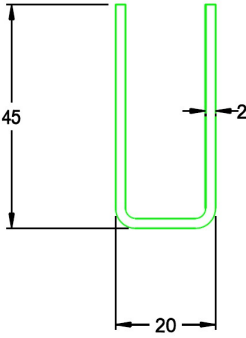
RF501	RF502	RF503	RF504
			
	-	-	-

Décision d'extension n° 1042-02 du 17 avril 2024
Decision of extension no. 1042-02 dated 17th April 2024

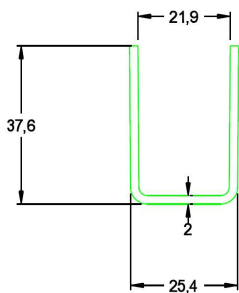
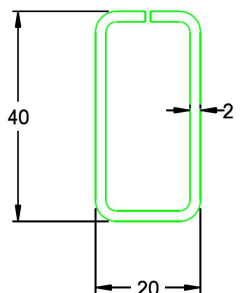
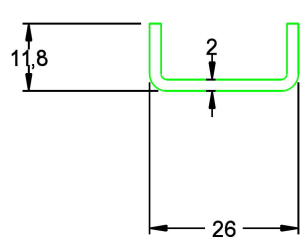
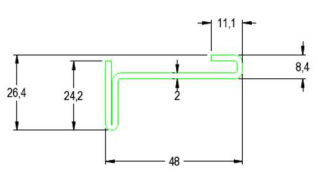
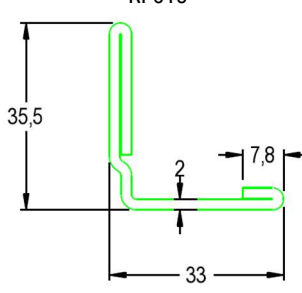
SOCREDIS Coulissant Wisio (6/15-2262)			
<p>RF511</p> 	<p>RF515</p> 	<p>RF516</p> 	<p>RF514</p> 
<p>RF513</p> 			

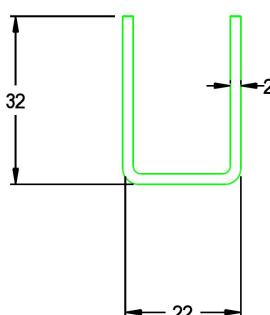
SOCREDIS Coulissant Wisio (6/15-2262) – les références de renforts ci-dessous ne sont pas décrites dans le DTA / The following reinforcement references are not described in the DTA			
<p>RF503</p> 	-	-	-

Décision d'extension n° 1042-02 du 17 avril 2024
Decision of extension no. 1042-02 dated 17th April 2024

VEKA Gamme 70 (6/16-2321)			
<p>V11-2-F23-63 (113.011.2)</p>	<p>V013-F24-111 (113.013)</p>	<p>V015-3-F43-28 (113.015.3)</p>	<p>V019-F24-79 (113.019)</p>
<p>V025-F24-75 (113.025)</p>	<p>V028-F24-107 (113.028)</p>	<p>V073-F24-106 (113.073)</p>	<p>V269-F41-88 (113.269.0)</p>
<p>V270-F11-110 (113.270)</p>	<p>V271-F24-98 (113.271)</p>	<p>V272-F24-99 (113.272)</p>	<p>V292-F38-29 (113.292)</p>
<p>V360-FC2-17 (113.360)</p>	<p>V399-F23-122 (113.399)</p>	<p>V430-FD2-23 (113.430)</p>	<p>V501-F41-68 (R050.1)</p>

Décision d'extension n° 1042-02 du 17 avril 2024
Decision of extension no. 1042-02 dated 17th April 2024

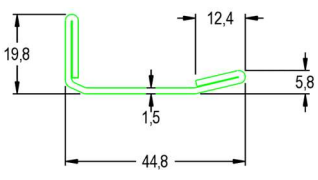
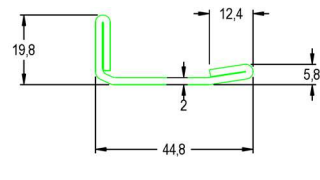
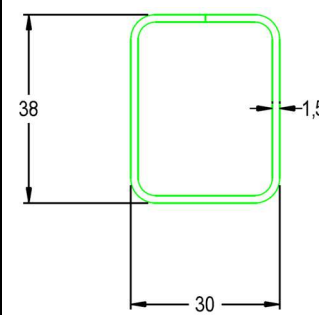
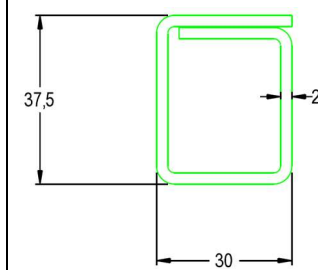
VEKA Gamme 70 (6/16-2321)			
<p>R0502-F41-67 (R050.2)</p> 	<p>R0503-F41-66 (R050.3)</p> 	<p>VM1-F24-96 (RTM 1)</p> 	<p>VM3-F43-21 (RTM 3)</p> 

VEKA Gamme 70 (6/16-2321) – les références de renforts ci-dessous ne sont pas décrites dans le DTA / The following reinforcement references are not described in the DTA

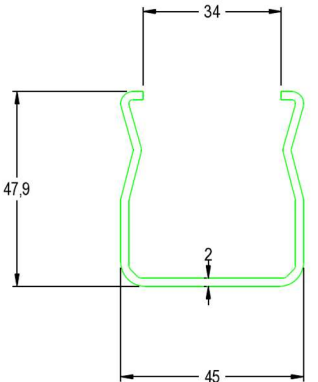
<p>V390-F23-117 (113.390)</p> 	-	-	-
---	---	---	---