

# Certificat

## Renforts acier pour produits de la baie

### Baies, portes, vérandas et accessoires

Le CSTB atteste que les produits mentionnés dans ce certificat sont conformes aux caractéristiques décrites dans le référentiel de certification **QB « Renforts acier pour produits de la baie » (QB44)** en vigueur après évaluation selon les modalités de contrôle définies dans ce référentiel.

En vertu de la présente décision, le CSTB accorde à :

**la société** **GEBHARDT STAHL GmbH**  
**Runtestrasse 33**  
**DE-59457 WERL**

**usine :** **GEBHARDT STAHL**  
**DE-59457 WERL**

le droit d'usage de la marque QB « Renforts acier pour produits de la baie » pour les produits objets de cette décision, pour toute sa durée de validité et dans les conditions prévues par les exigences générales de la marque QB et le référentiel mentionné ci-dessus.



07

**Décision d'extension n° 1039-07 du 06 février 2024**

**Cette décision se substitue à la décision d'extension n°1036-07 du 28 novembre 2023.**

Le certificat en vigueur peut être consulté sur le site internet <https://evaluation.cstb.fr> pour en vérifier sa validité.

## CARACTÉRISTIQUES CERTIFIÉES

>Caractéristiques dimensionnelles (géométrie et épaisseur)

>Classe de protection anti-corrosion : PZ275

**Ce certificat comporte 17 pages.**

**Correspondant :**

**Direction Baies et Vitrages**

[QB44@cstb.fr](mailto:QB44@cstb.fr)

+33(0)1 64 68 84 45

Par déléation  
du Président

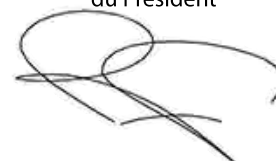

Florian RASSE

# Certificate

## Steel reinforcements for window products

### Windows, doors, verandas and accessories

CSTB hereby certifies that the products mentioned in this certificate comply with the characteristics described in the certification reference system **QB "Steel reinforcements for window products" (QB44)** in force after evaluation according to the control methods defined in this standard.

By virtue of the present decision, CSTB grants:

**the company** **GEBHARDT STAHL GmbH**  
**Runtestrasse 33**  
**DE-59457 WERL**

**plant :** **GEBHARDT STAHL**  
**DE-59457 WERL**

the right to use the QB mark "Steel reinforcements for window products" for the product covered under this decision, throughout its period of validity and under the conditions stipulated under the general requirements of the QB mark and the above-mentioned reference system.



07

**Decision of extension no. 1039-07 dated 6<sup>th</sup> February 2024**

**This decision replaces the extension decision n°1036-07 of 28 November 2023.**

This valid certificate may be watched on the following web site <https://evaluation.cstb.fr> to check its validity.

## CERTIFIED CHARACTERISTICS

- >Dimensional characteristics (geometry and thickness)
- >Corrosion protection class: PZ275

This certificate includes 17 pages.

Contact :

**Windows and Glazing Department**  
[QB44@cstb.fr](mailto:QB44@cstb.fr)  
+33(0)1 64 68 84 45

For CSTB  
On behalf of the President



Florian RASSE

**Décision d'extension n° 1039-07 du 6 février 2024**  
**Decision of extension no. 1039-07 dated 6th February 2024**

**ARBAN Grosfillex Altatherm – Altadécor – Altaduo – Altatwin – Therméa – Thermédécor – Therméaduo – TherméaTwin – Primalux – Primaluxduo – Sunbaie75 – Exaconfort75 (6/15-2239)**

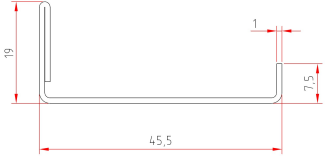
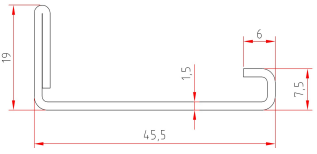
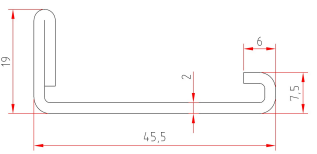
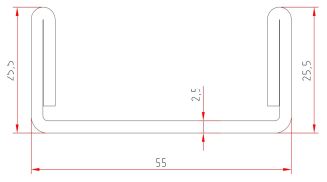
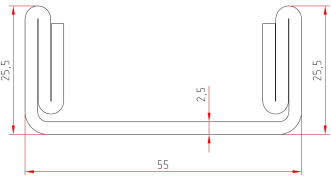
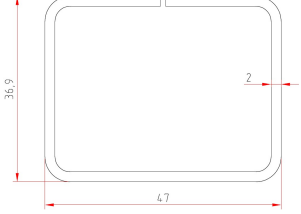
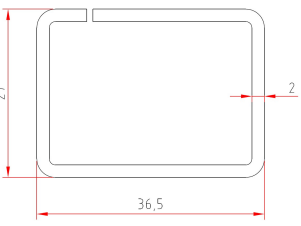
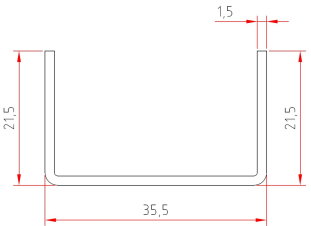
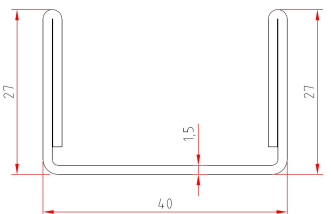
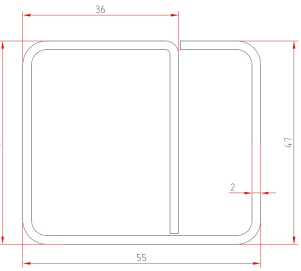
<p><b>R701.1</b></p> 	<p><b>R701.2</b></p> 	<p><b>R701.3</b></p> 	<p><b>R720.1</b></p> 
<p><b>R720.2</b></p> 	<p><b>RA721</b></p> 	<p><b>RA723</b></p> 	<p><b>RA724</b></p> 
<p><b>RA726</b></p> 	<p><b>RA731</b></p> 	<p>-</p>	<p>-</p>

**Décision d'extension n° 1039-07 du 6 février 2024**  
**Decision of extension no. 1039-07 dated 6th February 2024**

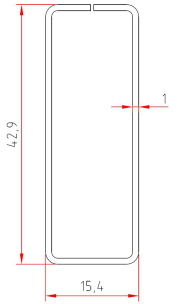
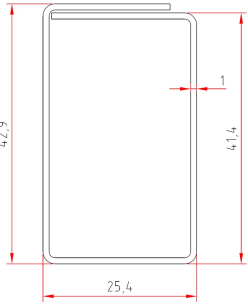
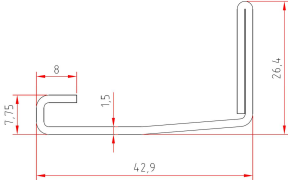
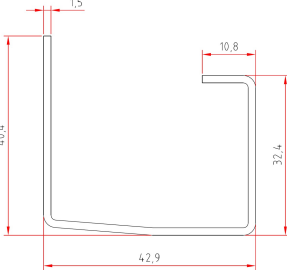
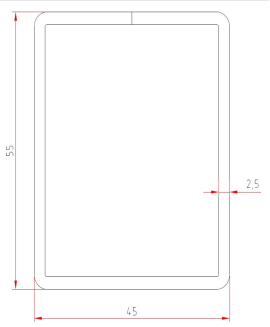
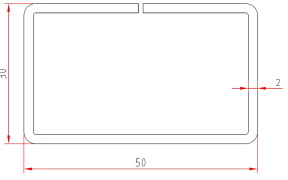
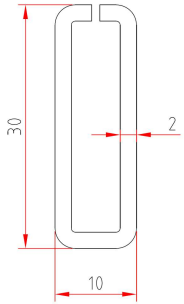
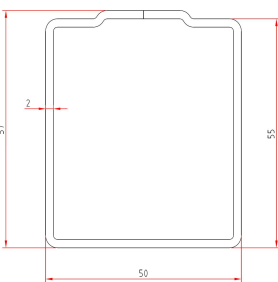
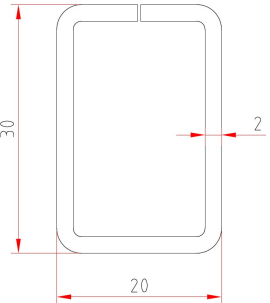
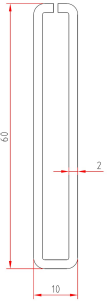
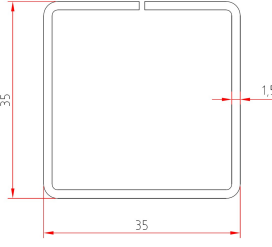
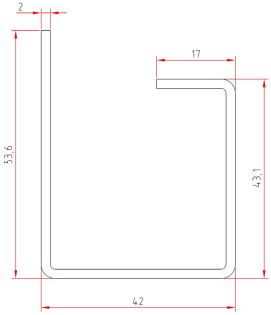
DECEUNINCK Plateforme Zendow (6/16-2298)			
<p><b>3200</b></p> 	<p><b>3202</b></p> 	<p><b>3214</b></p> 	<p><b>3216</b></p> 
<p><b>15961</b></p> 	<p><b>15161</b></p> 	<p><b>14592</b></p> 	<p><b>5227</b></p> 
<p><b>17045</b></p> 	<p><b>14591</b></p> 	<p><b>14347</b></p> 	<p><b>17046</b></p> 

**Décision d'extension n° 1039-07 du 6 février 2024**  
**Decision of extension no. 1039-07 dated 6th February 2024**

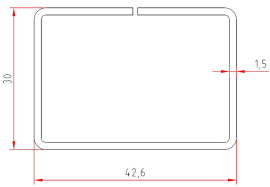
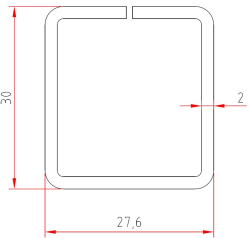
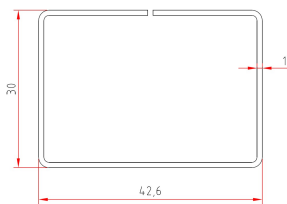
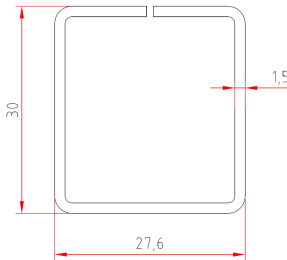
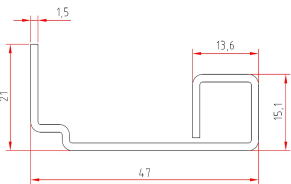
DECEUNINCK Plateforme Zendow (6/16-2298)			
17051	17040	17133	17131
			
5215	-	-	-
			

**Décision d'extension n° 1039-07 du 6 février 2024**  
**Decision of extension no. 1039-07 dated 6th February 2024**

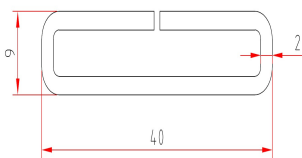
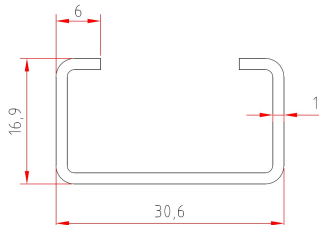
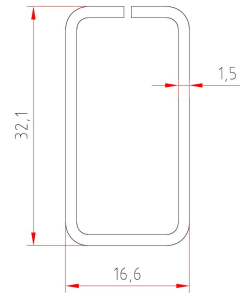
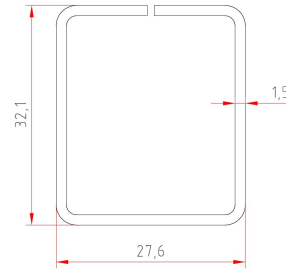
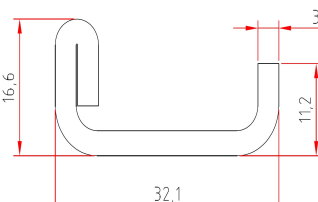
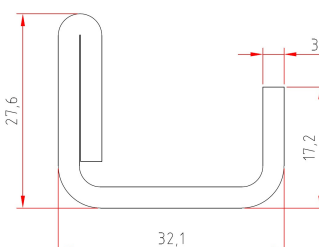
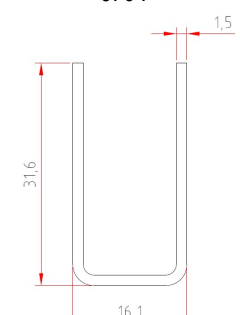
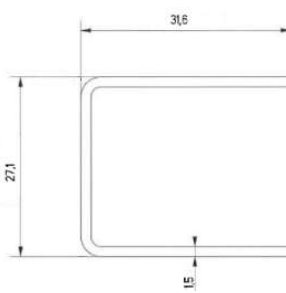
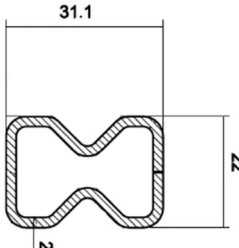
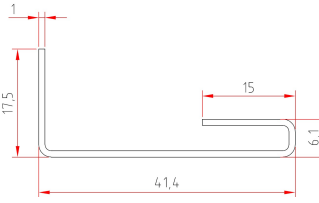
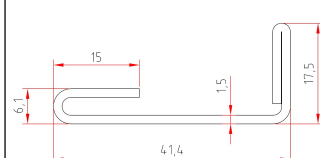
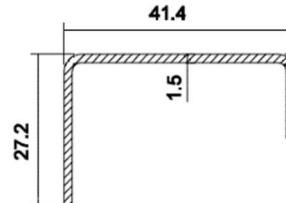
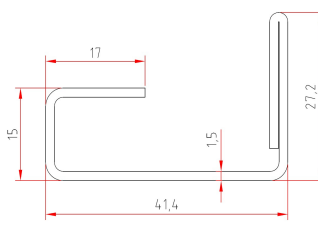
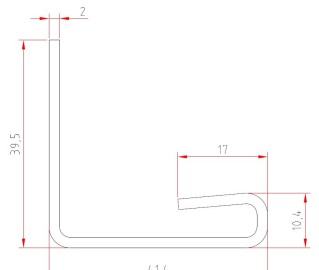
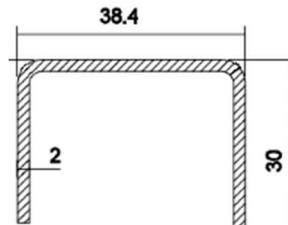
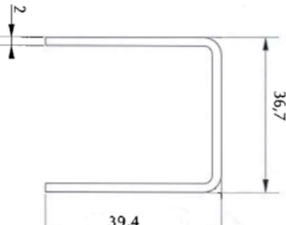
PROFIALIS Réponse (6/13-2151)			
<p>5100</p> 	<p>5170</p> 	<p>5700</p> 	<p>5701</p> 
<p>5702</p> 	<p>5703</p> 	<p>5704</p> 	<p>5705</p> 
<p>5715</p> 	<p>5719</p> 	<p>5720</p> 	<p>5721</p> 
<p>5722</p> 	<p>5723</p> 	<p>5724</p> 	<p>5725</p> 

Décision d'extension n° 1039-07 du 6 février 2024  
Decision of extension no. 1039-07 dated 6th February 2024

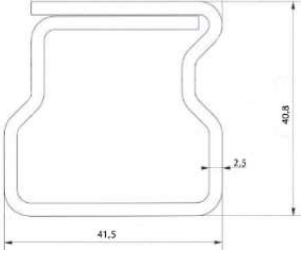
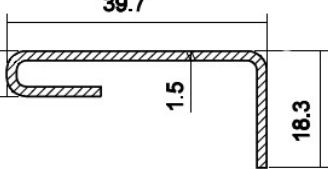
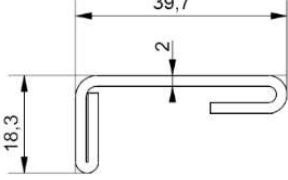
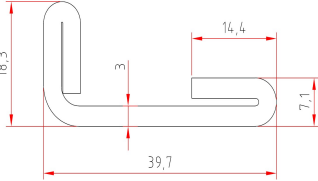
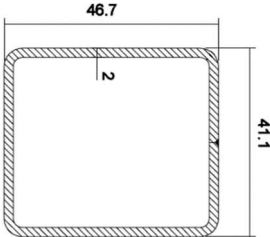
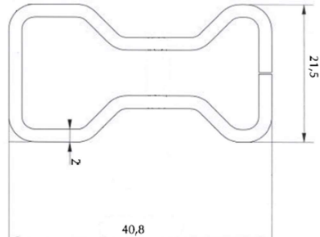
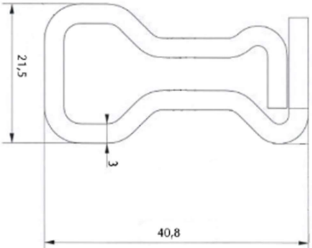
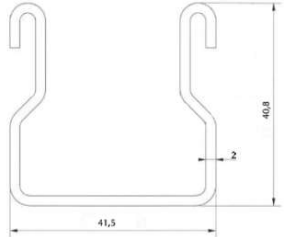
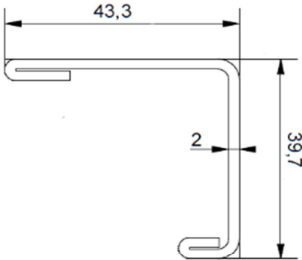
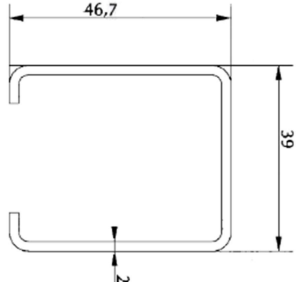
PROFIALIS Réponse (6/13-2151)			
<p>5737</p> 	<p>5779</p> 	<p>5780</p> 	<p>5781</p> 
<p>5727</p> 	<p>5734</p> 	<p>5735</p> 	<p>5736</p> 
<p>5783</p> 	<p>5787</p> 	-	-

**Décision d'extension n° 1039-07 du 6 février 2024**  
**Decision of extension no. 1039-07 dated 6th February 2024**

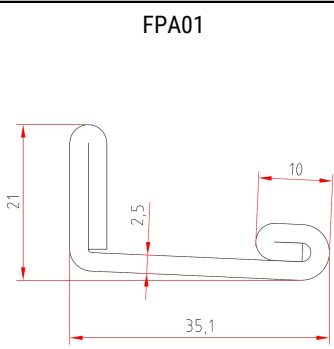
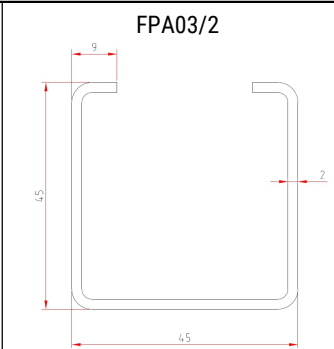
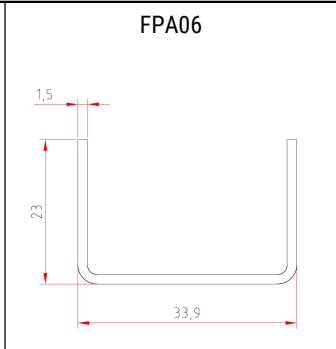
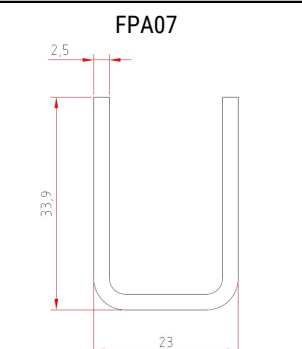
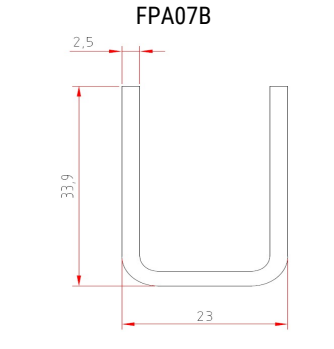
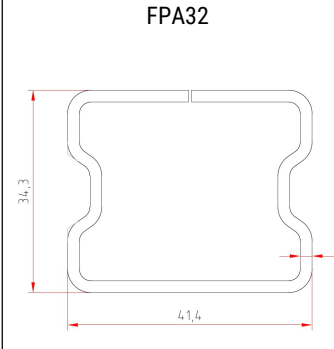
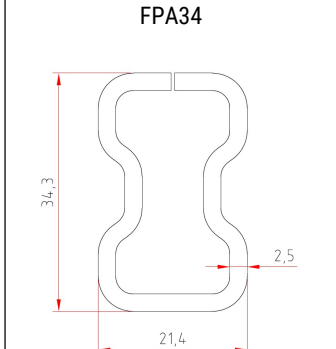
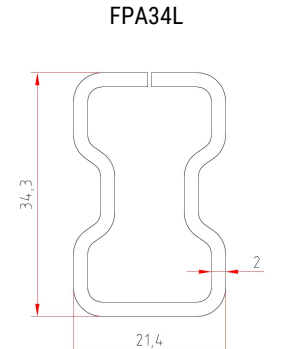
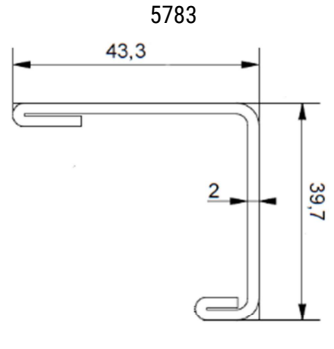
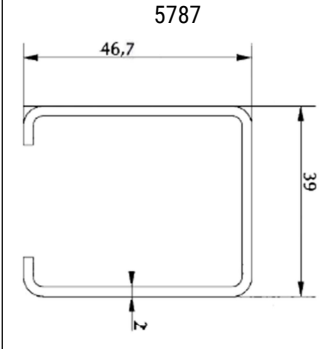
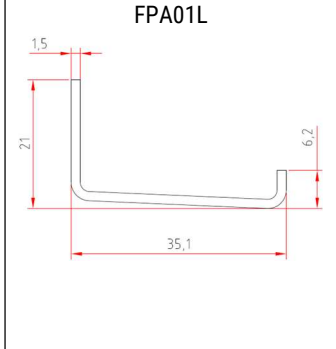
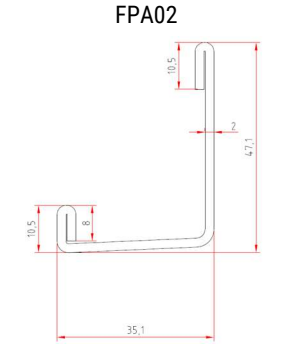
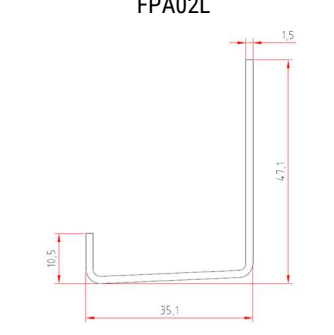
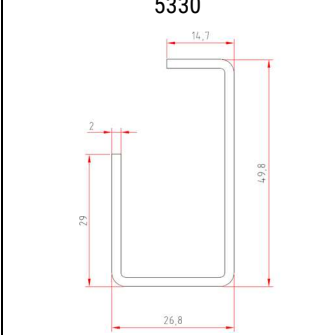
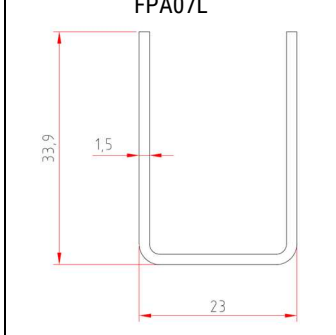
PROFIALIS Performance (6/12-2031)			
<p>FPA01</p> 	<p>FPA03/2</p> 	<p>FPA06</p> 	<p>FPA07</p> 
<p>FPA07B</p> 	<p>FPA32</p> 	<p>FPA34</p> 	<p>FPA34L</p> 
<p>5783</p> 	<p>5787</p> 	<p>FPA01L</p> 	<p>FPA02</p> 
<p>FPA02L</p> 	<p>5330</p> 	<p>FPA07L</p> 	<p>-</p>

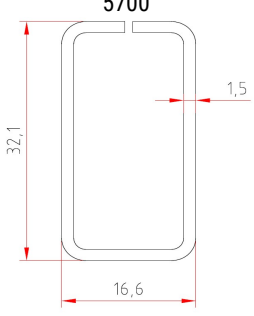
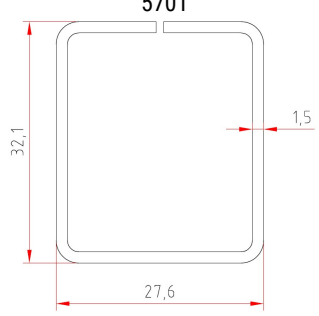

**Décision d'extension n° 1039-07 du 6 février 2024**  
**Decision of extension no. 1039-07 dated 6th February 2024**

PROFIALIS Horizon (6/12-2056)			
5700	5701	-	-
			

**Décision d'extension n° 1039-07 du 6 février 2024**  
**Decision of extension no. 1039-07 dated 6th February 2024**

**PROFINE TROCAL e.XCLUSIVE, KBE e.MOTION, KÖMMERLING e.VOLUTION (6/16-2335)**

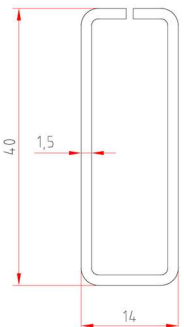
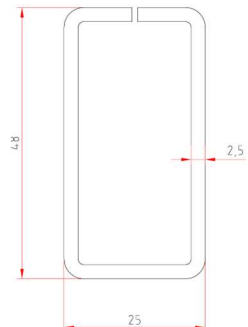
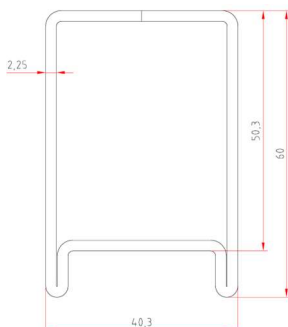
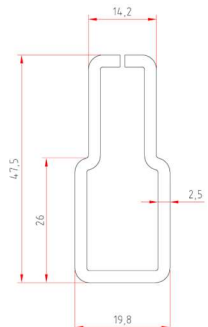
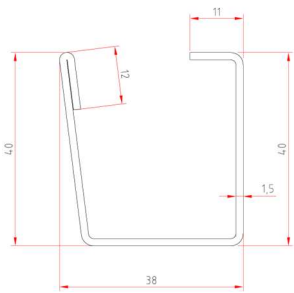
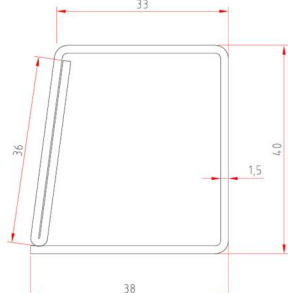
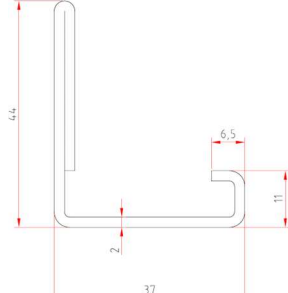
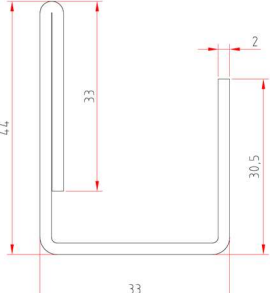
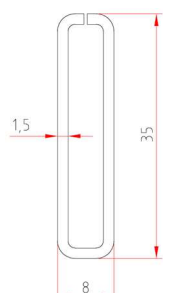
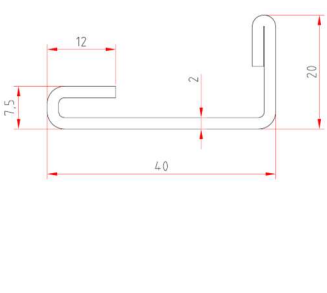
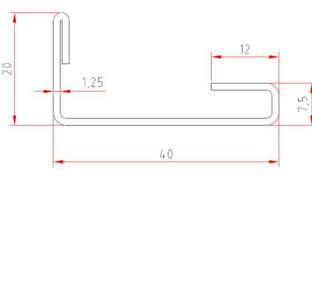
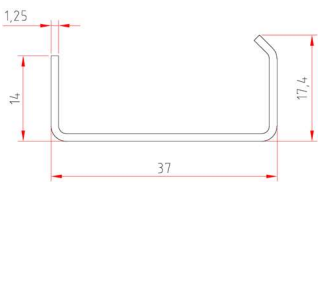
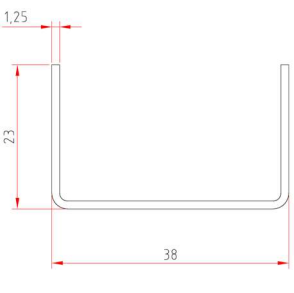
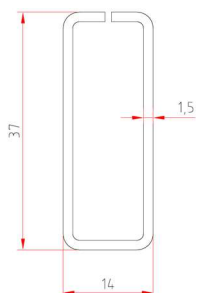
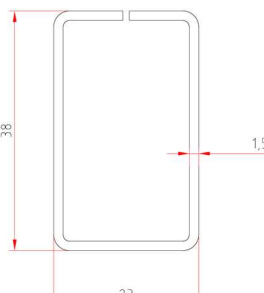
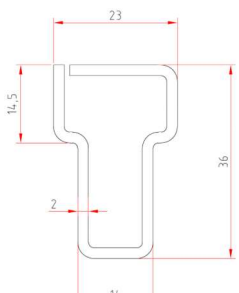
<p><b>9111</b></p> 	<p><b>9132</b></p> 	<p><b>V003</b></p> 	<p><b>V010</b></p> 
<p><b>V030</b></p> 	<p><b>V031</b></p> 	<p><b>V057.2</b></p> 	<p><b>V059.2</b></p> 
<p><b>V081</b></p> 	<p><b>V158</b></p> 	<p><b>V258</b></p> 	<p><b>V543</b></p> 
<p><b>V544</b></p> 	<p><b>V600</b></p> 	<p><b>V601</b></p> 	<p><b>V603</b></p> 

Décision d'extension n° 1039-07 du 6 février 2024  
Decision of extension no. 1039-07 dated 6th February 2024

PROFINE TROCAL e.XCLUSIVE, KBE e.MOTION, KÖMMERLING e.VOLUTION (6/16-2335)

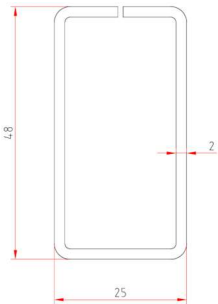
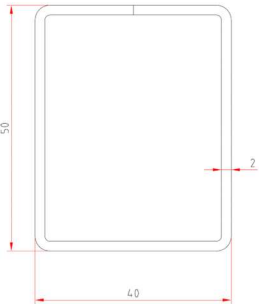
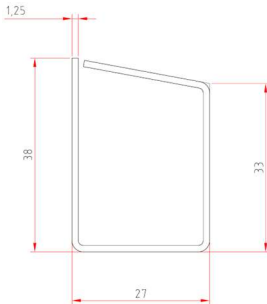
V618	V290	V045	-
			-

**Décision d'extension n° 1039-07 du 6 février 2024**  
**Decision of extension no. 1039-07 dated 6th February 2024**

**PROFINE TROCAL 76 ADVANCED, KBE 76 ADVANCED, KÖMMERLING 76 ADVANCED (6/16-2334)**

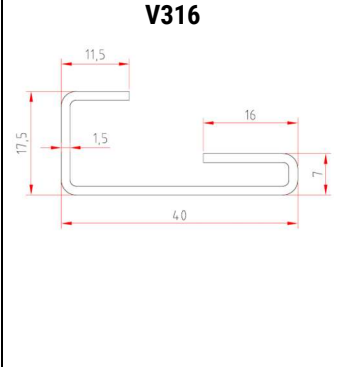
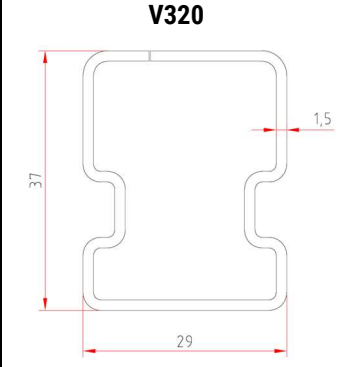
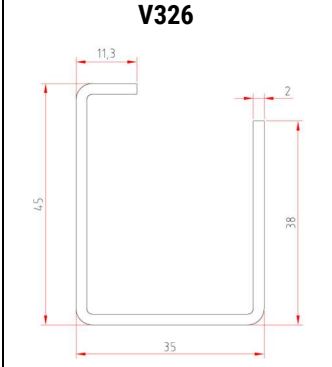
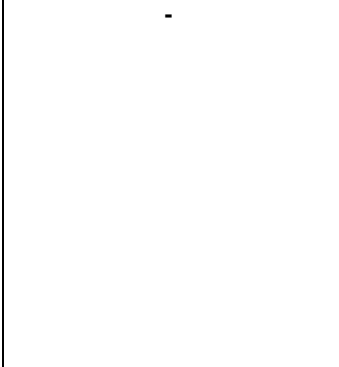
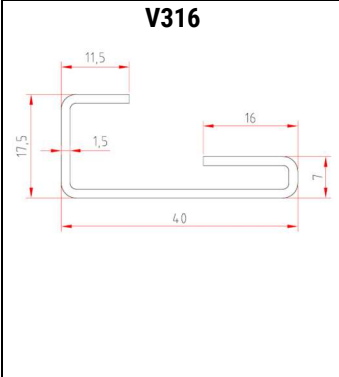
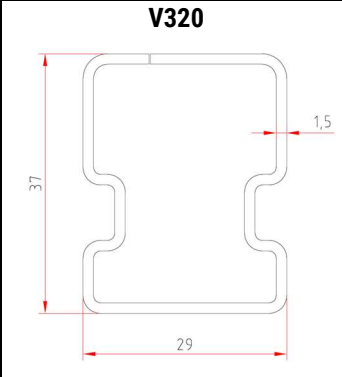
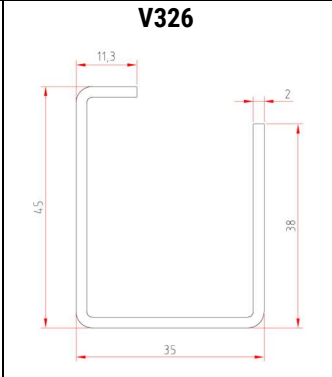
<b>V266</b>	<b>V306</b>	<b>V307</b>	<b>V314</b>
			
<b>V316</b>	<b>V320</b>	<b>V326</b>	-
			-

**Décision d'extension n° 1039-07 du 6 février 2024**  
**Decision of extension no. 1039-07 dated 6th February 2024**

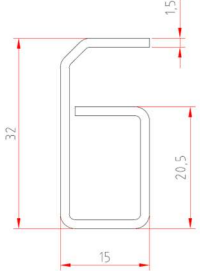
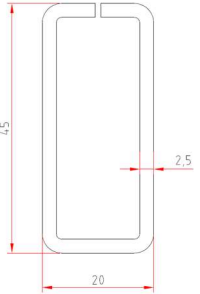
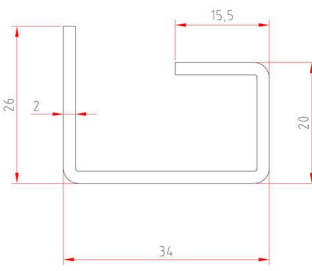
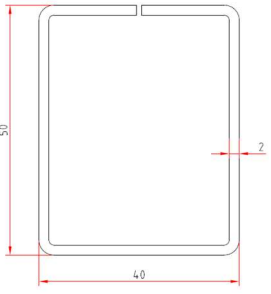
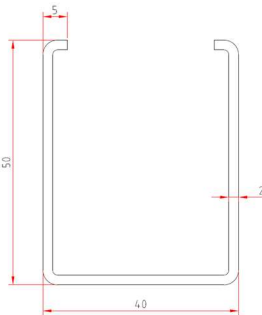
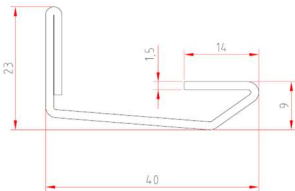
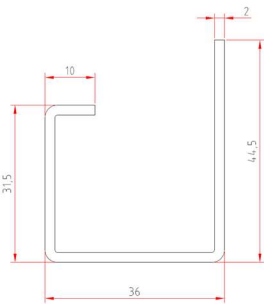
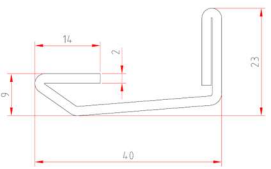
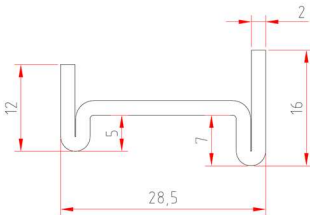
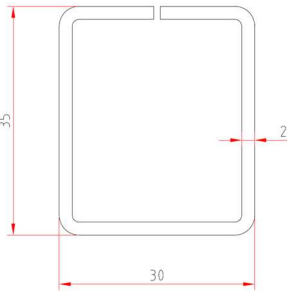
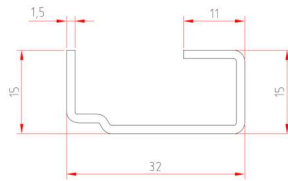
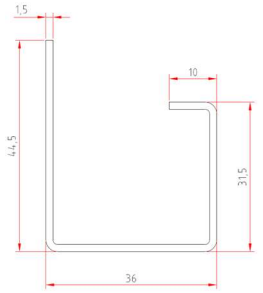
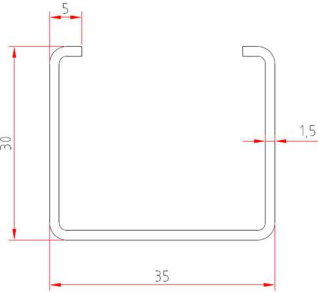
Rehau S729 (6/11-2003)			
<p>1383312</p> 	<p>1239353</p> 	<p>1241170</p> 	<p>1250475</p> 
<p>1268742</p> 	<p>1349696</p> 	<p>1351109</p> 	<p>1351696</p> 
<p>1354202</p> 	<p>1283089 - 357544</p> 	<p>1382812</p> 	<p>1349109</p> 
<p>1353740</p> 	-	-	-

**Décision d'extension n° 1039-07 du 6 février 2024**  
**Decision of extension no. 1039-07 dated 6th February 2024**

**Rehau S729 (6/11-2003) – les références de renforts ci-dessous ne sont pas décrites dans le DTA / The following reinforcement references are not described in the DTA**

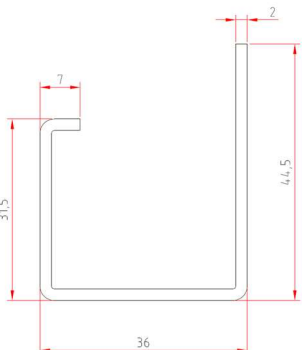
<p>357 869</p> 	-	-	-
--	---	---	---

**Décision d'extension n° 1039-07 du 6 février 2024**  
**Decision of extension no. 1039-07 dated 6th February 2024**

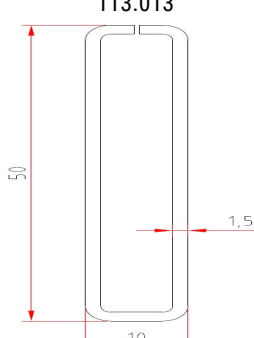
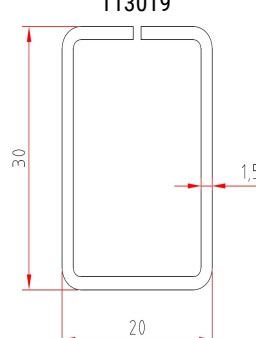
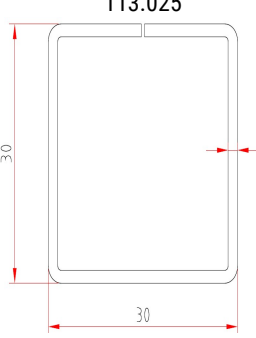
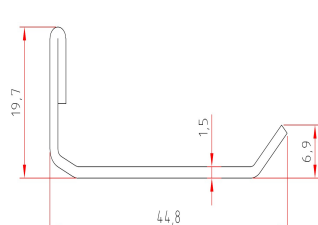
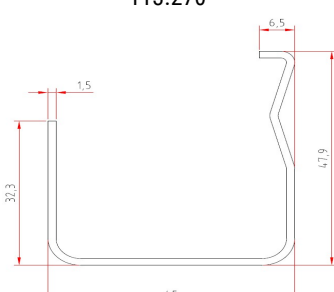
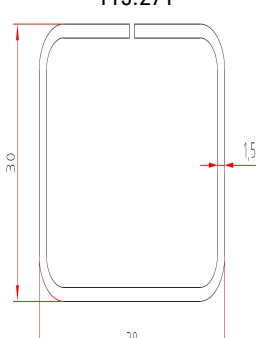
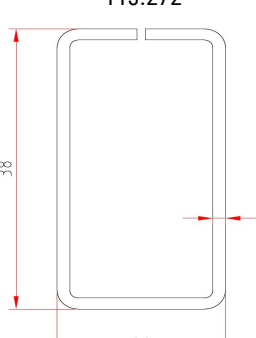
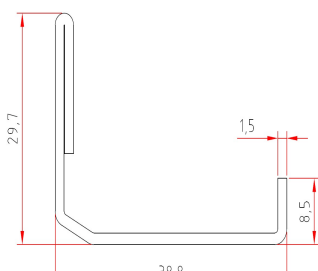
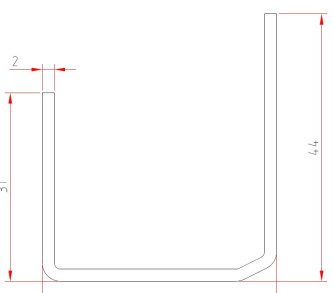
VEKA Gamme 70 (6/16-2321)			
<p>113.013</p> 	<p>113019</p> 	<p>113.025</p> 	<p>113.269</p> 
<p>113.270</p> 	<p>113.271</p> 	<p>113.272</p> 	<p>113.292</p> 
<p>113.360</p> 	-	-	-

**Décision d'extension n° 1039-07 du 6 février 2024**  
**Decision of extension no. 1039-07 dated 6th February 2024**

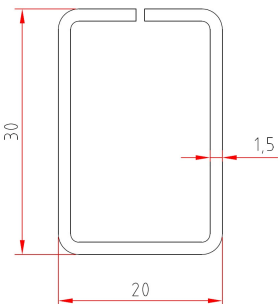
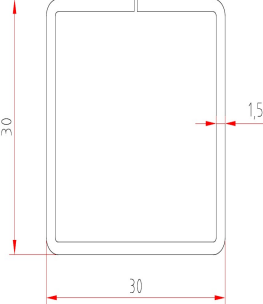
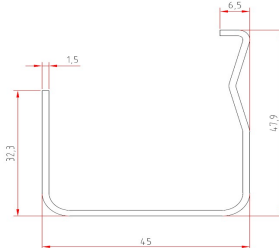
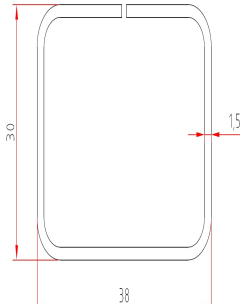
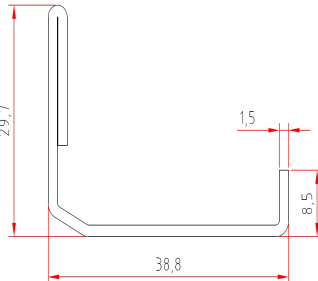
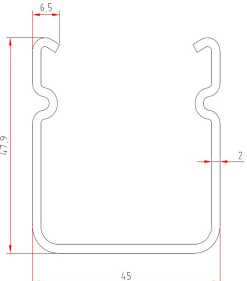
VEKA Gamme 82 (6/15-2266)			
<p>113.019</p> 	<p>113.025</p> 	<p>113.270</p> 	<p>113.271</p> 
<p>113.292</p> 	<p>113.368</p> 	-	-

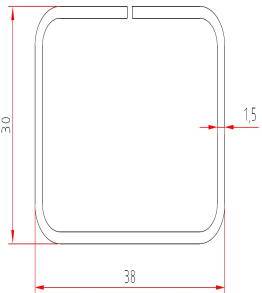

**Décision d'extension n° 1039-07 du 6 février 2024**  
**Decision of extension no. 1039-07 dated 6th February 2024**

VEKA Gamme 70 mm MD (6/13-2150)			
<p>113.271</p> 	-	-	-