

Certificat

Renforts acier pour produits de la baie

Baies, portes, vérandas et accessoires

Le CSTB atteste que les produits mentionnés dans ce certificat sont conformes aux caractéristiques décrites dans le référentiel de certification QB « Renforts acier pour produits de la baie » (QB44) en vigueur après évaluation selon les modalités de contrôle définies dans ce référentiel.

En vertu de la présente décision, le CSTB accorde à :

la société **MFO S.A.**
70A UL. KOZUSZKI-PARCEL
PL-96500 SOCHACZEW

usine : **MFO S.A.**
PL-96500 SOCHACZEW

le droit d'usage de la marque QB « Renforts acier pour produits de la baie » pour les produits objets de cette décision, pour toute sa durée de validité et dans les conditions prévues par les exigences générales de la marque QB et le référentiel mentionné ci-dessus.



11

Décision d'admission n° 1008-11 du 16 mars 2022

Le certificat en vigueur peut être consulté sur le site internet <http://evaluation.cstb.fr> pour en vérifier sa validité.

CARACTÉRISTIQUES CERTIFIÉES

> Caractéristiques dimensionnelles (géométrie et épaisseur)

> Classe de protection anti-corrosion : PZ275

Ce certificat comporte 16 pages.

Correspondant :

Direction Baies et Vitrages
QB44@cstb.fr

Par délégation
du Président

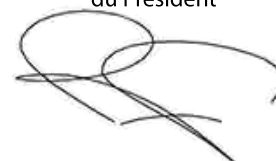

Florian RASSE

Certificate

Steel reinforcements for window products

Windows, doors, verandas and accessories

CSTB hereby certifies that the above-mentioned product complies with the characteristics described in the certification reference system QB "Steel reinforcements for window products" (QB44) in force, following an assessment performed according to the inspection procedures set out in this reference system.

By virtue of the present decision, CSTB grants :

the company **MFO S.A.**
70A UL. KOZUSZKI-PARCEL
PL-96500 SOCHACZEW

plant : **MFO S.A.**
PL-96500 SOCHACZEW

the right to use the QB mark "Steel reinforcements for window products" for the product covered under this decision, throughout its period of validity and under the conditions stipulated under the general requirements of the QB mark and the above-mentioned reference system.



11

Decision of admission no. 1008-11 dated 16 March 2022

This valid certificate may be watched on the following web site <http://evaluation.cstb.fr> to check its validity.

CERTIFIED CHARACTERISTICS

- > Dimensional characteristics (geometry and thickness)
- > Corrosion protection class : PZ275

This certificate includes 16 pages.

Contact :

Windows and Glazing Department
QB44@cstb.fr

For CSTB
On behalf of the President



Florian RASSE

Décision d'admission n° 1008-11 du 16 mars 2022
Decision of admission no. 1008-11 dated 16 March 2022

ALUPLAST Idéal 2000 (6/16-2301)			
<p>229001</p>	<p>229007</p>	<p>229023</p>	<p>229024</p>
<p>229025</p>	<p>229026</p>	<p>229027</p>	<p>229028</p>
<p>229030</p>	<p>229031</p>	<p>229034</p>	<p>229037</p>
<p>229038</p>	<p>229047</p>	<p>229055</p>	<p>229056</p>

Décision d'admission n° 1008-11 du 16 mars 2022
Decision of admission no. 1008-11 dated 16 March 2022

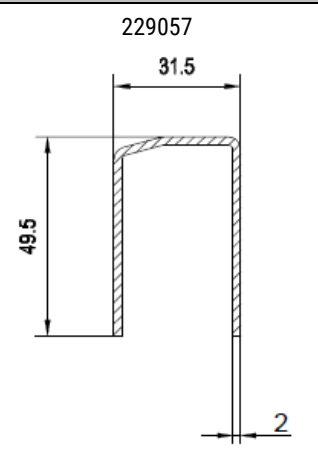
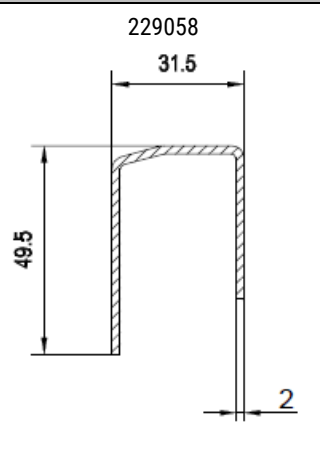
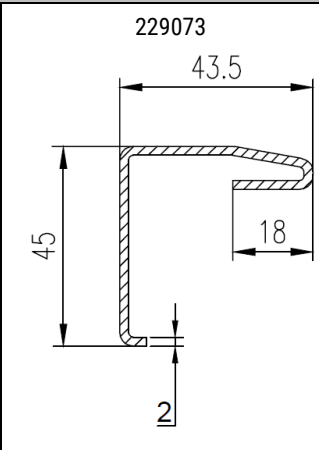
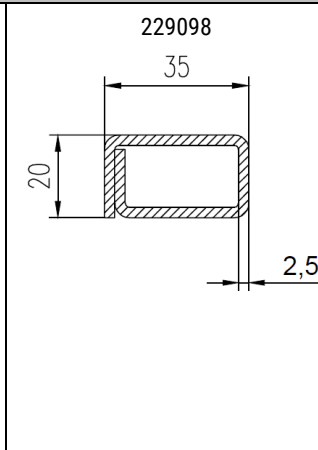
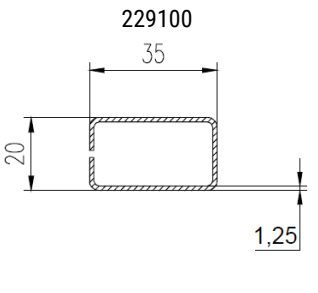
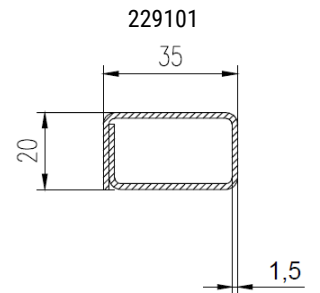
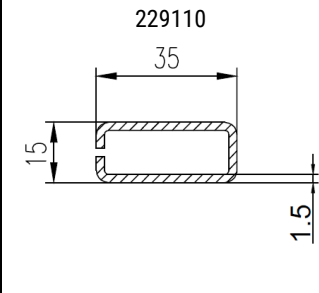
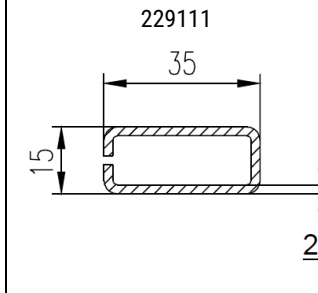
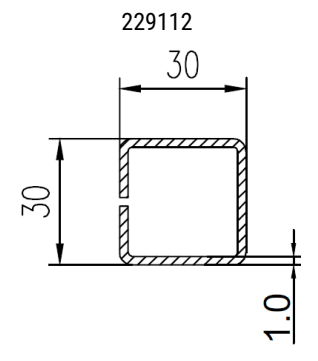
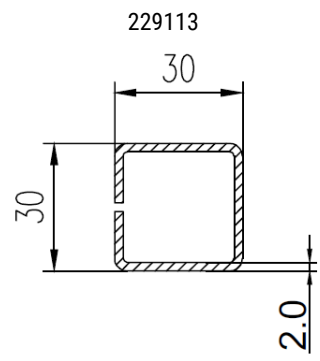
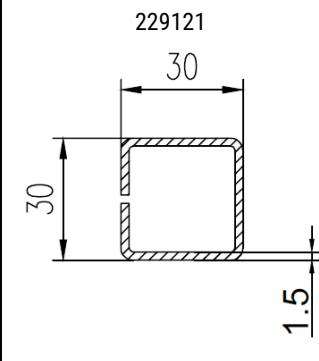
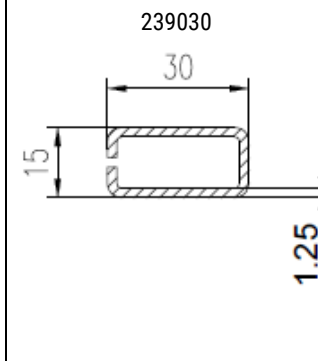
ALUPLAST Idéal 2000 (6/16-2301)			
<p>229057</p> 	<p>229058</p> 	<p>229073</p> 	<p>229098</p> 
<p>229100</p> 	<p>229101</p> 	<p>229110</p> 	<p>229111</p> 
<p>229112</p> 	<p>229113</p> 	<p>229121</p> 	<p>239030</p> 

Décision d'admission n° 1008-11 du 16 mars 2022
Decision of admission no. 1008-11 dated 16 March 2022

ALUPLAST Ideal 4000 (6/12-2095)			
<p>209192</p>	<p>209193</p>	<p>229017</p>	<p>229023</p>
<p>229024</p>	<p>229025</p>	<p>229026</p>	<p>229027</p>
<p>229028</p>	<p>229029</p>	<p>229030</p>	<p>229098</p>
<p>229100</p>	<p>229101</p>	<p>229112</p>	<p>229113</p>

Décision d'admission n° 1008-11 du 16 mars 2022
Decision of admission no. 1008-11 dated 16 March 2022

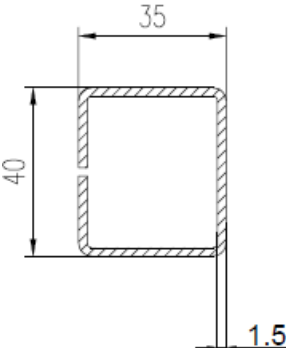
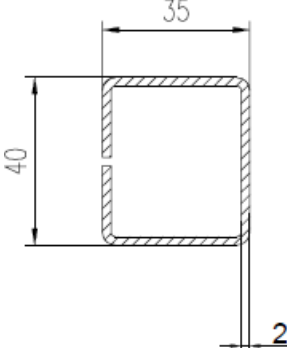
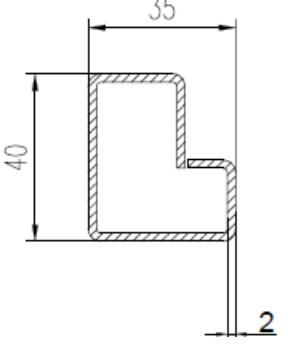
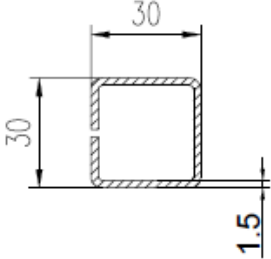
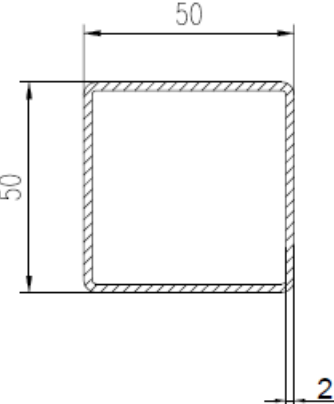
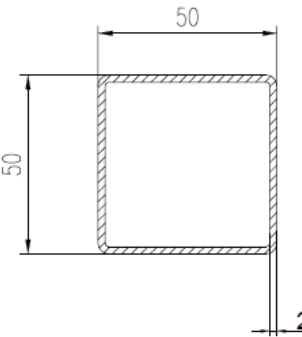
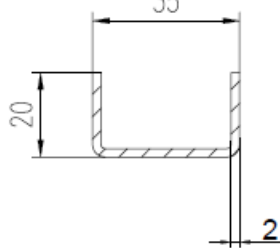
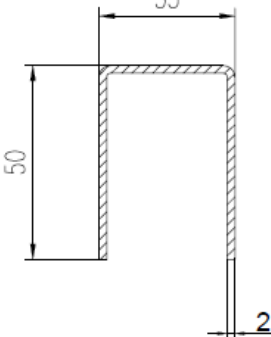
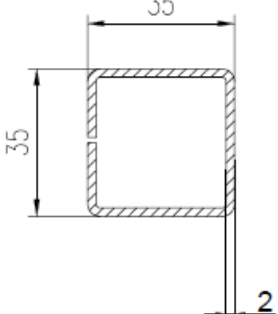
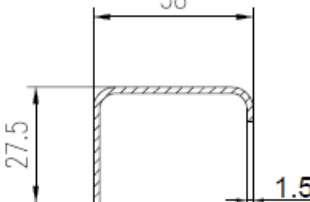
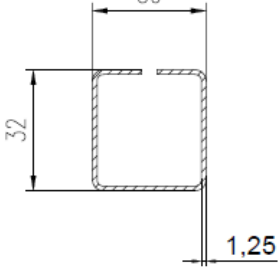
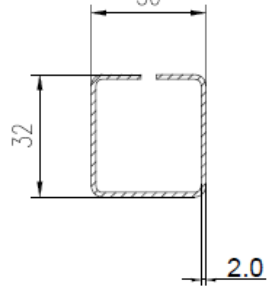
ALUPLAST Ideal 4000 (6/12-2095)			
<p>229114</p> 	<p>229115</p> 	<p>229120</p> 	<p>229121</p> 
<p>229135</p> 	<p>229137</p> 	<p>249004</p> 	<p>249007</p> 
<p>249009</p> 	<p>249010</p> 	<p>249014</p> 	<p>249015</p> 

Décision d'admission n° 1008-11 du 16 mars 2022
Decision of admission no. 1008-11 dated 16 March 2022

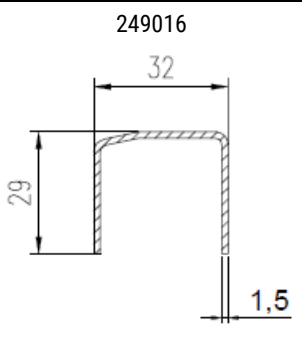
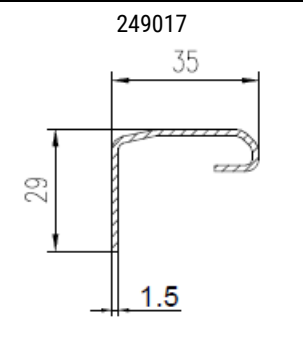
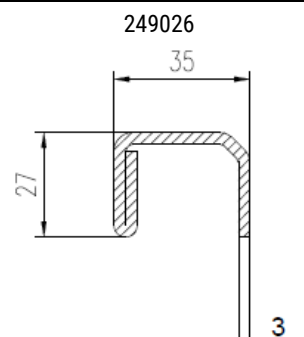
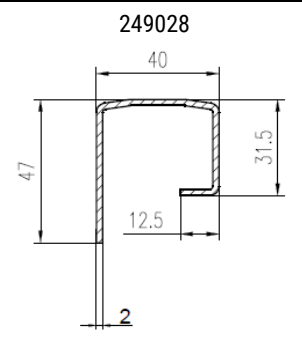
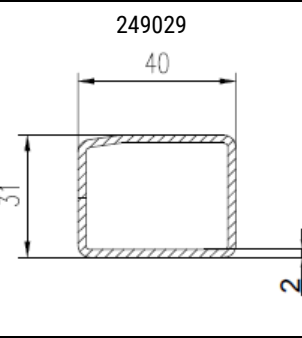
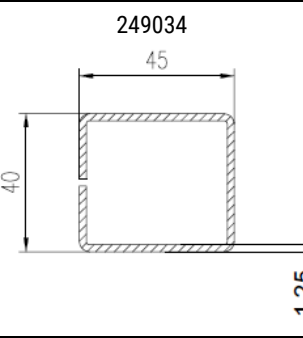
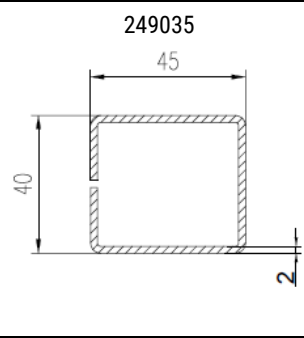
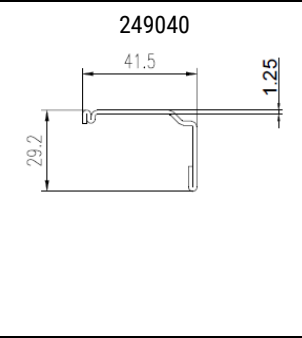
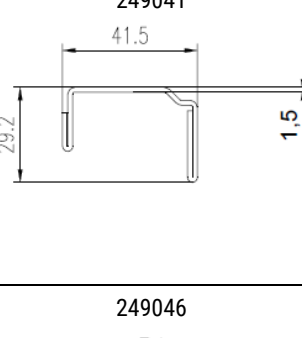
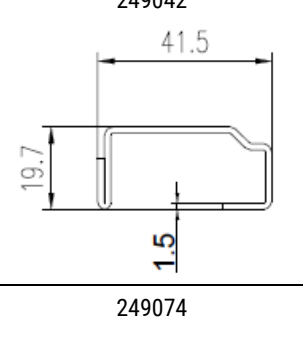
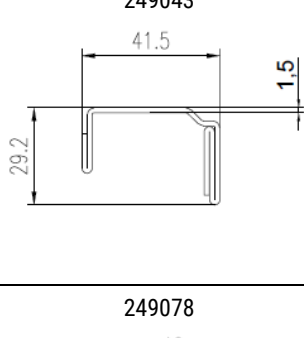
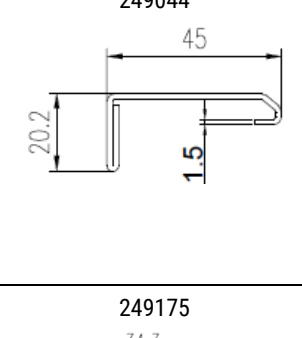
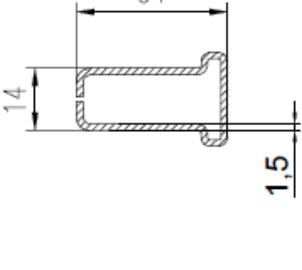
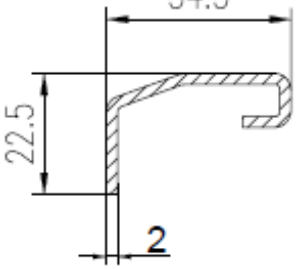
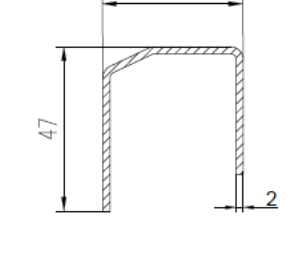
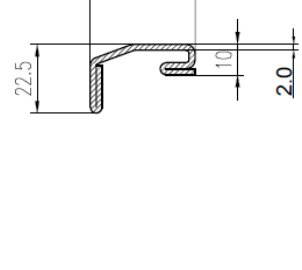
ALUPLAST Ideal 4000 (6/12-2095)			
<p>249016</p> 	<p>249017</p> 	<p>249026</p> 	<p>249028</p> 
<p>249029</p> 	<p>249034</p> 	<p>249035</p> 	<p>249040</p> 
<p>249041</p> 	<p>249042</p> 	<p>249043</p> 	<p>249044</p> 
<p>249046</p> 	<p>249074</p> 	<p>249078</p> 	<p>249175</p> 

Décision d'admission n° 1008-11 du 16 mars 2022
Decision of admission no. 1008-11 dated 16 March 2022

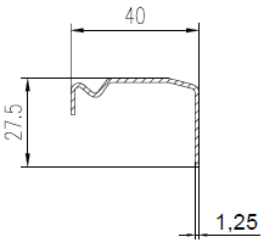
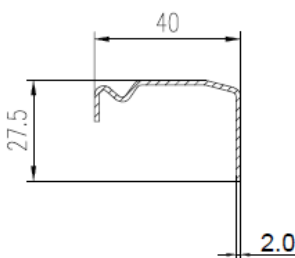
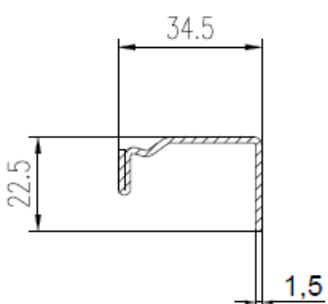
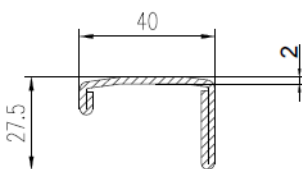
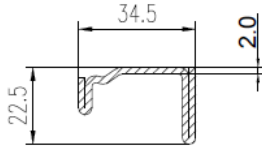
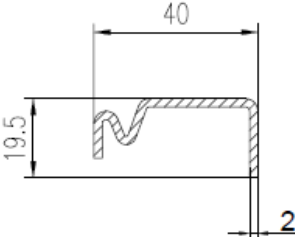
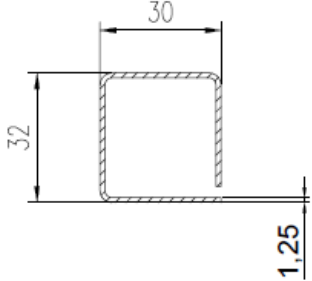
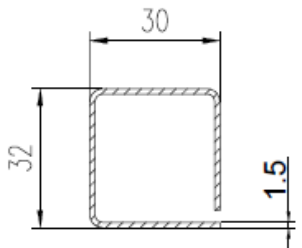
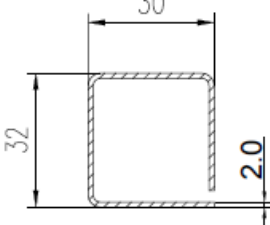
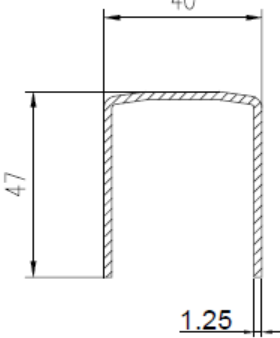
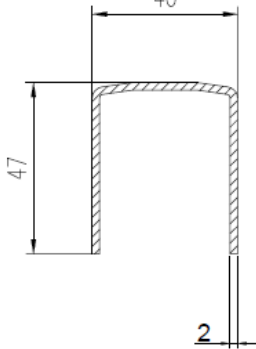
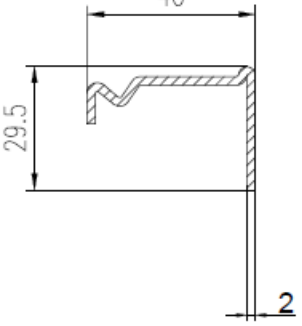
ALUPLAST Ideal 4000 (6/12-2095)			
<p>259020</p> 	<p>259021</p> 	<p>259024</p> 	<p>259026</p> 
<p>259028</p> 	<p>259094</p> 	<p>259105</p> 	<p>259106</p> 
<p>259107</p> 	<p>279028</p> 	<p>279029</p> 	<p>289021</p> 

Décision d'admission n° 1008-11 du 16 mars 2022
Decision of admission no. 1008-11 dated 16 March 2022

ALUPLAST Idéal 5000 (6/15-2274)			
<p>229045</p>	<p>229098</p>	<p>229100</p>	<p>229101</p>
<p>229107</p>	<p>229112</p>	<p>229113</p>	<p>229114</p>
<p>229115</p>	<p>229121</p>	<p>249004</p>	<p>249014</p>
<p>249015</p>	<p>249019</p>	<p>249031</p>	<p>249034</p>

Décision d'admission n° 1008-11 du 16 mars 2022
Decision of admission no. 1008-11 dated 16 March 2022

ALUPLAST Idéal 5000 (6/15-2274)			
<p>249035</p>	<p>259010</p>	<p>259011</p>	<p>259020</p>
<p>259021</p>	<p>259024</p>	<p>259026</p>	<p>259028</p>
<p>259043</p>	<p>259044</p>	<p>259067</p>	

Décision d'admission n° 1008-11 du 16 mars 2022
Decision of admission no. 1008-11 dated 16 March 2022

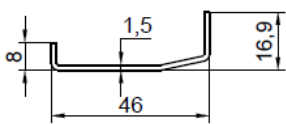
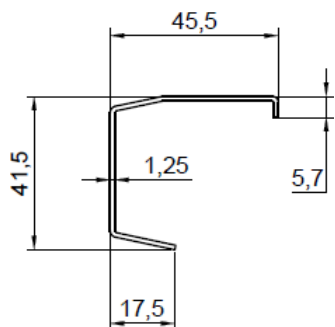
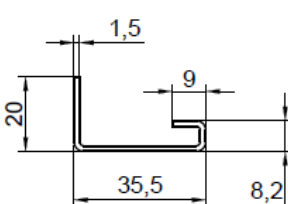
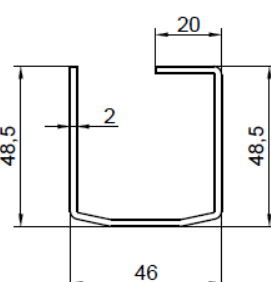
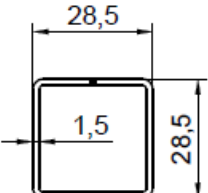
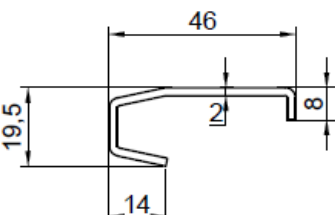
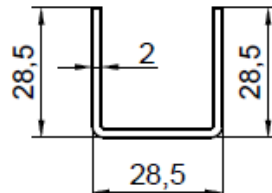
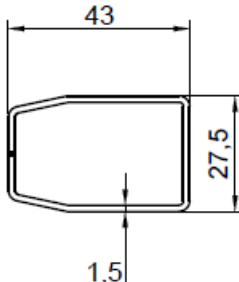
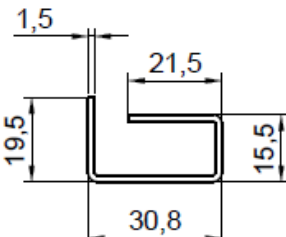
GEALAN Série 8000 (6/16-2322)			
<p>4709</p> 	<p>4712</p> 	<p>4715</p> 	<p>8706</p> 
<p>8715</p> 	<p>8724</p> 	<p>8727</p> 	<p>8751</p> 
<p>8760</p> 	-	-	-

Décision d'admission n° 1008-11 du 16 mars 2022
Decision of admission no. 1008-11 dated 16 March 2022

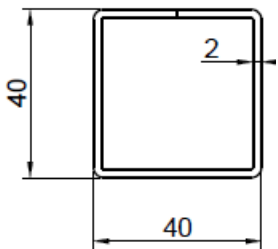
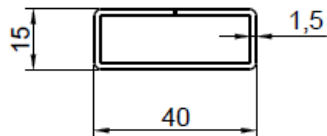
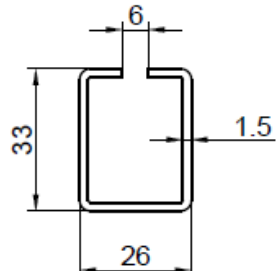
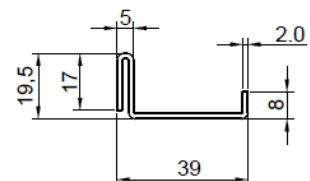
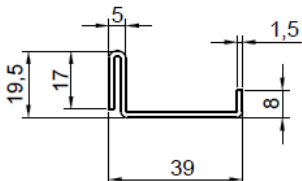
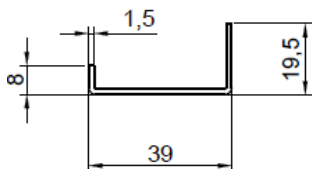
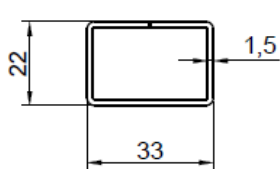
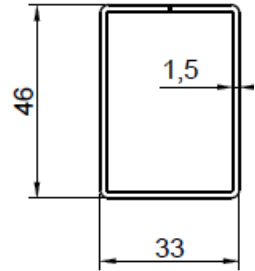
SCHÜCO CT 70 (6/16-2345)			
<p>201210</p> 	<p>202667</p> 	<p>202870</p> 	<p>202871</p> 
<p>202872</p> 	<p>202873</p> 	<p>202876</p> 	<p>202884</p> 

Décision d'admission n° 1008-11 du 16 mars 2022
Decision of admission no. 1008-11 dated 16 March 2022

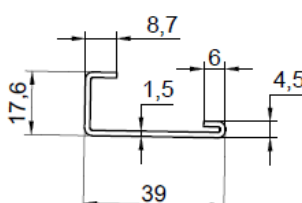
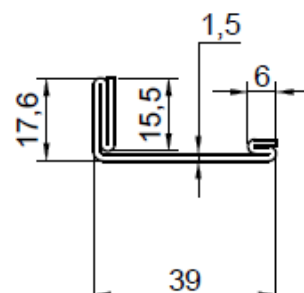
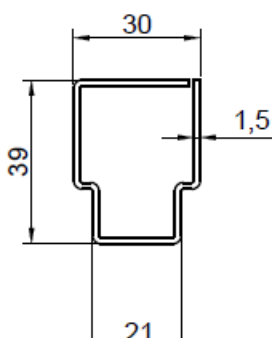
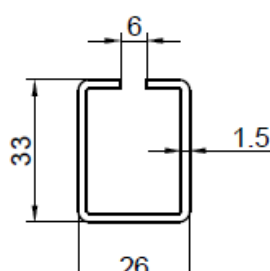
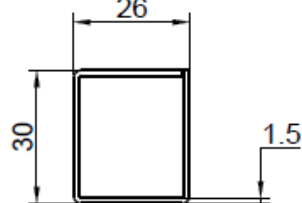
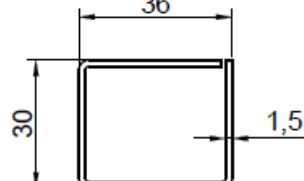
SCHÜCO Living 82 (6/20-2417)			
<p>202723</p> 	<p>202724</p> 	<p>202729</p> 	<p>202870</p> 
<p>202893</p> 	<p>202895</p> 	-	-

Décision d'admission n° 1008-11 du 16 mars 2022
Decision of admission no. 1008-11 dated 16 March 2022

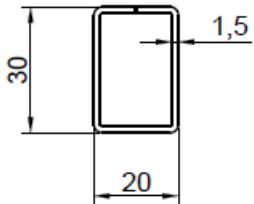
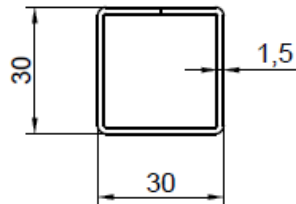
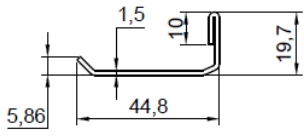
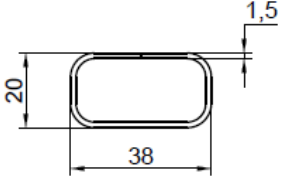
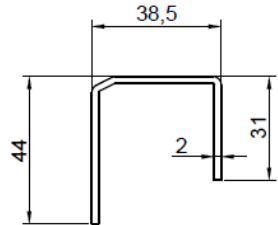
VEKA Gamme 70 (6/16-2321)			
<p>113.019</p> 	<p>113.025</p> 	<p>113.269</p> 	<p>113.272</p> 
<p>113.360</p> 	-	-	-

Décision d'admission n° 1008-11 du 16 mars 2022
Decision of admission no. 1008-11 dated 16 March 2022

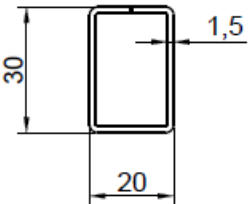
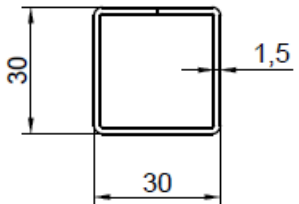
VEKA Gamme 76 (6/20-2409)			
<p>113019</p> 	<p>113025</p> 	-	-

Décision d'admission n° 1008-11 du 16 mars 2022
Decision of admission no. 1008-11 dated 16 March 2022

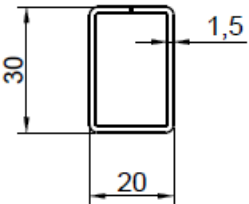
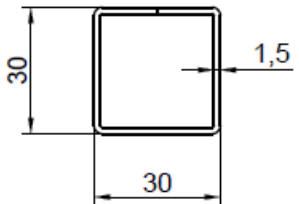
VEKA Gamme 82 (6/15-2266)			
<p>113019</p> 	<p>113025</p> 	-	-